

# **CMAS Cave Diving Standards and Training System**



## **CMAS International**

15.09.2007

V4.0

author: Beat A. Mueller  
Cave Diving Working Group  
CMAS International

[translated from German reference text]



## Table of Content

	<b>Page</b>
Preface	4
Used terms, abbreviations and definitions	5
 <b>Part I: The CMAS Cave Diving Training System</b> 	
1. Course classification and content	9
2. CMAS Standard Cave Diving Training Courses and -Certificates	10
3. CMAS Specialty Cave Diving Training Courses and -Certificates	13
4. Overview on CMAS Cave Diving Training- and Certification System	16
 <b>Part II: Cave Zones, Equipment and Safety Rules</b> 	
5. Cave Zone 1 (daylight zone)	18
6. Cave Zone 2 (zone of complete darkness)	19
7. Cave Zone 3 (highest competence level)	20
8. Requirements for Divers and Equipment / Application- and Safety-Rules	21
 <b>Part III: Standards for Cave Diver levels</b> 	
9. CMAS Cave Diver 1 / CD1 (Cavern Diver)	39
10. CMAS Cave Diver 2 / CD2 (Cave Diver)	41
11. CMAS Cave Diver 3 / CD3 (Full Cave Diver)	44
12. Overview on the governing parameters of the CMAS standards for Cave Diver levels 1 to 3	47
 <b>Part IV: Standards for Cave Diving Instructor levels</b> 	
13. CMAS Cave Diving Instructor 1 / CDI1 (Cavern Diving Instructor)	49
14. CMAS Cave Diving Instructor 2 / CDI2 (Full Cave Diving Instructor)	52
15. CMAS Cave Diving Instructor 3 / CDI3 (Cave Diving Staff Instructor)	55
16. Overview on the governing parameters of the CMAS standards for Cave Diving Instructor levels 1 to 3	58
17. Cross-overs and Exception Handling	59
18. Maintaining active status for CMAS Cave Diving Instructors	60



### Part V: Appendices

Appendix 1a:	Designations of CMAS cave diving certificates & levels	62
Appendix 1b:	Comparison of different international cave diver certification systems	62
Appendix 2:	UW-Communication in Cave Diving	63
Appendix 3:	Guidelines for the use of gases, rebreathers, stage tanks and DPVs during CMAS standard cave diving training courses	66
Appendix 4:	Compulsory equipment for CMAS cave diving courses	68
Appendix 5:	Guidelines for assessments	69
Appendix 6a:	Standard drills & exercises for practical evaluation at CMAS Cave Diver 1 level	71
Appendix 6b:	Standard drills & exercises for practical evaluation at CMAS Cave Diver 2 level	72
Appendix 6c:	Standard drills & exercises for practical evaluation at CMAS Cave Diver 3 level	74
Appendix 7:	Theory-Tests (topics, structure, number of questions)	76
Appendix 8:	The CMAS cave diver's etiquette	78
Appendix 9:	Current line sizes and US designation codes	79
Appendix 10:	Knots, Bends and Hitches	80



## Standards & Training System

### Preface

The present standards and the underlying training program focus cave diving as it is performed of an ever increasing number of recreational divers. They regard cave diving as a challenging expansion of their recreational outdoor activities thus the term "recreational cave diving" will be used several times.

However, there is no sports competition behind this wording! In the past, exactly such competition between rivaling groups or persons, each trying to impress the others by longer penetrations and deeper dives has led - besides human negligence, inadequate equipment and missing training - again and again to serious, mostly deadly accidents.

For the majority of these recreational cave divers however it is the unique diving experience, handling with complex technical gear, the personal physical and mental challenge and the love for nature in its unspoiled form which counts. Interest in the more scientific background for cave genesis, hydrology, karst phenomena etc. is mostly limited to situations where such knowledge is important for safety reasons.

It was never the goal of CMAS, and will never be, to train *cavers*. For such activities a lot of well-known and well-organized local or national caver- and cave research organizations exist with all the required competencies. Even on international level such organizations do exist (UIS). Such organizations offer a home place to those interested in the scientific research in the cave environment.

On the "wet side" however, CMAS and all affiliated national federations have proved their competency in diver training for decades. They guarantee a serious and adequate training, be it in clubs or in commercially organized diving schools and professional training centers.

As a consequence, neither side has any reason, to think in a negative or jealous way of the other. There were and there still are great cavers and cave scientists *and* great cave divers. It's also a matter of fact that in most areas with accessible water-filled caves and attractive for the diving tourist (Australia, Mexico, Florida), an appropriate certification is compulsory. In many countries cave diving without an accepted certificate is prohibited by law. Vice versa, hardly any untrained novice will expose himself to the inherent risks and dangers of a dry cave exploration.

Despite the volume of the present standards it is impossible to cover all imaginable special circumstances and there is no intention to do so. The present standards have their roots back in 1998, thus are relatively young and have been subject to several adaptations and modifications to actual developments within the past 2-3 years. The so-called "common sense" still is one of the most prominent factors in a delicate environment such as cave diving.

It is very unfortunate and sad to learn - especially in the area of so-called "tec-diving" - of the existence of organizations and "schools of thinking" which impose to their followers a refined type of mental terror. The underlying concept is very simple: develop a philosophy which is carved into stone, which must never be questioned, which has the only true answer for every existing and imaginable situation and question and which prescribes every detail of your equipment, down to the last and tiniest piece. In most of these organizations the intended effect is simply to fill the pouches of their leaders who are the major shareholder of the producers of such required equipment. Personal preferences and individuality are regarded as a shame and a sign of personal incompetence and stupidity. Thus, the world is divided in two groups: one are the followers who do it right and vigilantly fight for their righteous case, and the others are the "strokes" that do it wrong. Such a way of thinking is light-years away from the CMAS philosophy.

CMAS training was and stays different: it stands for freedom of ideas, for open minds, takes into account the European liking for individuality and demonstrates the students the various possibilities to solve most of the problems in more than just one dictatorial way. CMAS accepts the diving community as intelligent adults, capable of weighing the advantages and disadvantages of various viewpoints. However it is strict and restrictive where safety requires this.

Rudolfstetten, June 18, 2005

Beat A. Müller  
Head of Cave Diving Working Group of CMAS International  
Member CMAS Technical Diving Committee



## Standards & Training System

### Used terms, abbreviations and definitions

CMAS	Confédération Mondiale des Activités Subaquatiques / World Underwater Federation
NACD	National Association of Cave Divers
NSS/CDS	National Speleological Society / Cave Diving Section
CDAA	Cave Diving Association of Australia
CDG (UK)	Cave Diving Group (UK)
SNSS	Scuola Nazionale di Speleologia Subacquea
NAUI	National Association of Underwater Instructors
PADI	Professional Association of Diving Instructors
IANTD	International Association of Nitrox and Technical Divers
TDI	Technical Diver International
SSI	Scuba Schools International
CMAS.CH	CMAS Switzerland, member TC of CMAS International
TD	Technical Diving (Nitrox, Trimix, Caves)
CD	Course Director (Staff Instructor); synonym: Instructor Trainer
cd	cave dive/cave diving
owd	open water dive(s)/diver
z1, 2, 3	zone 1 (Cavern), 2 (Cave), 3 (Full Cave, Penetration)
CD 1, 2, 3	Cave Diver (1, Cavern Diver ), (2, Cave Diver), (3, Full Cave Diver)
CDI 1, 2, 3	Cave Diving Instructor (1, Cavern Diving Instructor), (2, Full Cave Diving Instructor), (3, Cave Diving Staff Instructor)
D* / ** / ***	CMAS (Open Water) Diver 1-star / 2-star / 3-star
old: M* / ** / ***	old: CMAS (Open Water) Moniteur (Instructor) 1-star / 2-star / 3-star
new: I* / ** / ***	new: CMAS (Open Water) Instructor 1-star / 2-star / 3-star
DM	Divemaster / Diveguide on level CMAS D***
penetration zone	CMAS zone 3 (after restriction / squeeze)
sinkhole	a round shaped cavity (dome), with an opening created by the collapsed ceiling
sump	Sumps are defined as water filled sections of a cave within an otherwise air-filled passage (German word: "siphon").
spring; effluent cave, out-flow cave	A spring is defined as the entrance to a cavern or cave system in which the water flows out of the ground. For cave divers it's of the safer type because for returning, much less physical exertion is needed combined with less gas consumption as during penetration.
estavelle; intermittent resurgence /-exurgence	Water filled caves with the current periodically changing from inflow to outflow and vice versa. Like this the caves has the characteristic of a spring at one time and the one of a sinkhole another time. Reasons may be tides (caves on the coast) or seasonal changes of the water table in relation to the receiving water level. This kind of cave can be very malicious, especially with a change of current during the dive.
siphon, sink, swallow hole, swallet water	A siphon is defined as the entrance to a cavern or cave system in which the water flows into ground. Diving in siphons is discouraged, but if done then only with great caution and with adequate technical support (scooter, safety lines etc.). Rule of Thirds MUST NOT be applied.

# CMAS Cave Diving

---



## Standards & Training System

Penetration- (zone)	CMAS zone 3 (after a minor restriction or even smaller)
minor restriction	A cross section area that does not permit 2 divers to pass with their equipment at the same time (threshold zone 2 -> zone 3).
major restriction	A cross section area that a single diver can just negotiate in a back-mount configuration
squeeze	A cross section area that a single diver can negotiate with a side-mount configuration
tight squeeze	A cross section area that a single diver can only negotiate with a no-mount, single- tank configuration, while pushing this tank in front of him.
gap	(unplanned/unintended) interruption of a main line
jump	(intended) gap at a junction/bifurcation from main line to a side passage
visual jump	generally a small jump (ranging from some centimeters to meters) which has been traversed without a jump-line (strictly forbidden)
reel	generic designation for a line reel
spool	very small reel without handle
primary reel	main reel (mostly 1 per group with several 100meters of line)
safety reel	personal reel; for finding lost line etc.; never to be given away
gap reel	a reel for crossing/repairing/fixing a gap
jump reel	a reel for temporary crossing a jump
directional marker	a coloured marker in the form of an arrow which may be attached to the line, always pointing to the entry/exit.
non-directional marker	a coloured marker in the form of a round disk which may be attached to the line. Because of their form sometimes called cave-cookies or line-cookies.
distance marker	(in French: métrage) generally a piece of duct tape permanently attached to the line
isolator valve	valve in the middle of a double-tank manifold, used in emergencies for interrupting the connection between the two tanks
stage tank	additional tank, carried during the dive and/or deposited in the cave
HID	High Intensity Discharge light
LED	Light Emission Diode (lighting system based on this technology)
EAD	Equivalent Air Depth: depth with equivalent p <sub>N2</sub> as for air-breathing
MOD	Maximum Operation Depth: max. operation depth of a normoxic or hyperoxic gas with p <sub>O2</sub> = p <sub>O2_max.tol.</sub> (1.4-1.6bar)
MinOD	Minimum Operation Depth: min. operation depth of a hypoxic gas with p <sub>O2</sub> = p <sub>O2min.tol.</sub> (mostly 0.18 bar)
Ceiling	a) the upper part ("roof") of a cave passage b) the shallowest possible ascent depth which may be reached due to the actual decompression requirements

# CMAS Cave Diving

---



## **Standards & Training System**

CPR	Cardiopulmonary Resuscitation
BLS	Basic Life Support
MC	Multiple Choice (-test)



## Part I:

# The CMAS Cave Diving Training System

### ***Legal Advice***

- In all countries in which regional or national laws and regulations are imposed on diving in general or for particular diving activities (such as Nitrox, Trimix, Cave), those rules are strictly to be abided.
- It is self-understanding that such laws and regulations precede all similar rules from any private organizations (incl. all diving organizations such as CMAS).
- Under no circumstances violations of such legal requirements will be endorsed or supported by CMAS.
- It is therefore the sole responsibility of each diver, dive guide, instructor and course director to procure such relevant legal information in due time. This responsibility cannot be waived or delegated.
- All divers and instructors must be aware of the fact that in case of an incident the present standards may be used by investigating authorities as a source for specified duties. Breach of such duties may be judged as negligence or gross negligence in court.





## Standards & Training System

### 1. Course classification and contents

The CMAS Cave Diving Training System is composed of the following 2 course types:

- Standard Cave Diving Courses
- Specialty Cave Diving Courses

The following diagram shows the structure of the training system and the links and interfaces between the systems.

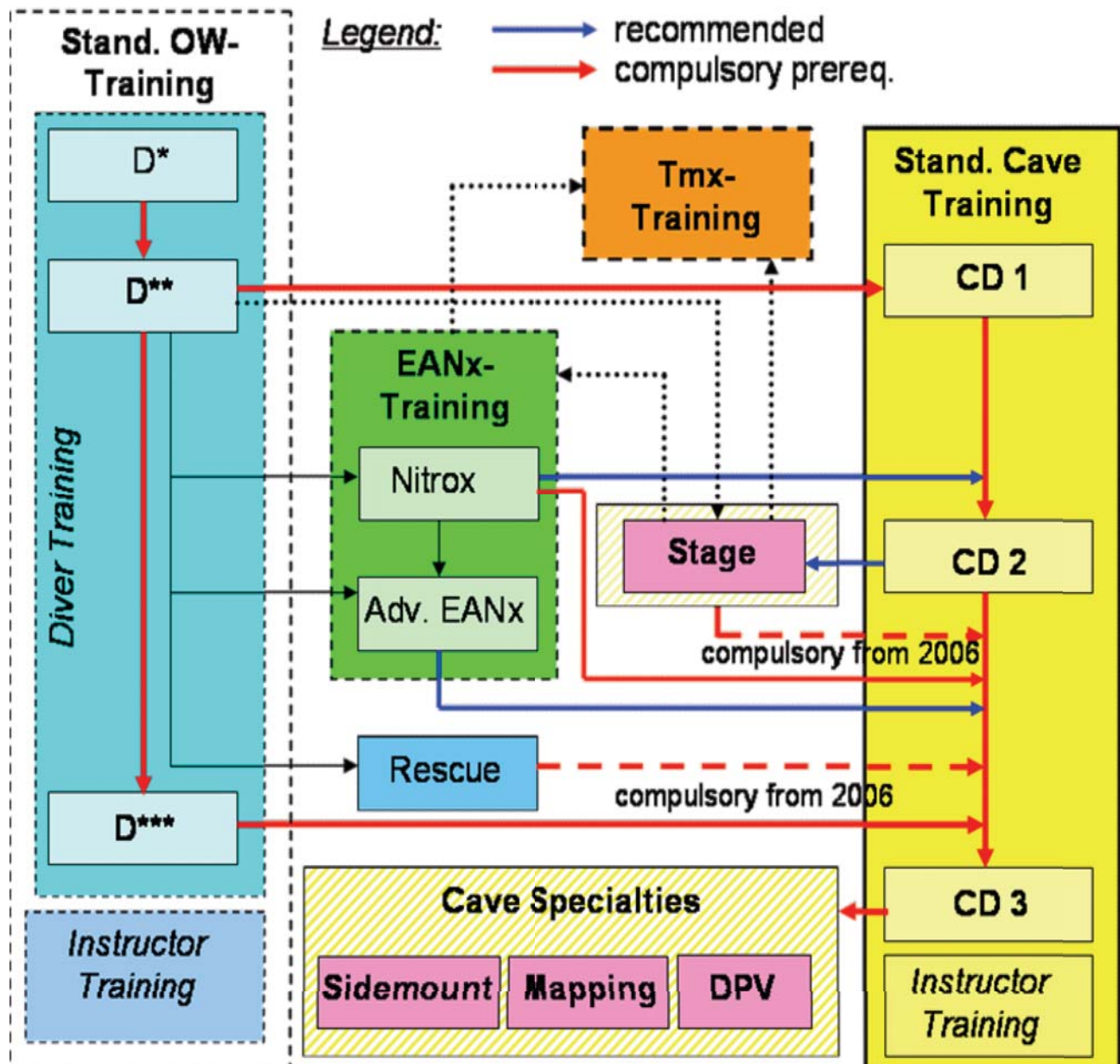



## Standards & Training System

### 2. Standard Cave Diving Courses and -Certificates

#### 2.1 Cave Diver I (Cavern Diver)

(for detailed course content and prerequisites ref. to chapt. 7)

Cavern diving is the exploration of an overhead environment while remaining within the portion of the light zone, which is illuminated by sunlight. It differs from cave diving in that, while cave divers may penetrate thousands of meters, cavern divers go no further than a linear distance of 50m from the surface. The maximum depth for diving in a cavern is 20m.

##### **Objectives:**

The course is designed to train the open water diver to dive safely in an overhead environment. This course is an extension of recreational diving designed for the use of a SINGLE TANK, and upon completing the course, a diver will possess the skills, knowledge, dive planning abilities, and problem solving techniques to safely cavern dive within no-decompression limits.

##### **Content:**

Problem solving in cavern diving skill development includes, but is not limited to body positioning (trim), buoyancy control, emergency procedures, line following, the use of reels, and propulsion techniques. Accident analysis forms the basis of this learning experience.

A minimum of four dives are performed in zone 1 in a minimum of two different cave systems. Special emphasis on the unique environment includes on silting, entanglement, disorientation. Equipment modification is also an essential part of this course. *The Cavern Diver course is in no way intended to provide instruction for cave diving.*

Upon successful completion, the candidate will be qualified as a CMAS Cave Diver I (Cavern Diver).

Prerequisites: \*\* Diver CMAS or equivalent, 25 OW dives of which are 5 night dives, valid medical

Duration: min. 2.5 days

Classroom: min. 3 hrs

Dives: min. 4

Caverns: min. 2 different systems

Constraints: diver restricted to zone 1, single tank, linear distance of 50m to surface, max. depth 20m, no restrictions, no Ts, no jumps.

#### 2.2 Cave Diver II (Apprentice Cave Diver)

(for detailed course content and prerequisites ref. to chapt. 8)

The Cave Diver II course represents the second step of the training required to complete the CMAS cave diver III level (Full Cave Diver) and develops basic cave diving skills with limited penetrations of the cave environment.

This program introduces students to the fundamental principles of full cave diving, but is not intended to cover all facets of full cave diving. Students are highly encouraged to move on to the next level of training before attempting to plan and execute more complex dives. The maximum depth for Cave Diver II level is 30m.

##### **Objectives:**

It is a recreational cave diving course. Emphasis is placed on dive planning and skill refinement through actual cave dives. Techniques learned through the earlier Cavern Diver course are critiqued and expanded. Exposure to different cave diving scenarios is the foundation of this training.

The course develops and establishes minimum skills, knowledge, dive planning and preparation, problem solving procedures, swimming techniques, emergency procedures and the basic abilities necessary to safely cave dive within limited penetrations, using DOUBLE TANKS through-

# CMAS Cave Diving

---



## Standards & Training System

out. Mastering buoyancy control, working with a reel, a light, and awareness in the cave is necessary to safely enjoy another dimension in cave diving

### **Content:**

If deemed necessary, an open-water evaluation and orientation dive is completed to review cave diving techniques (preliminary assessment). A minimum of four cave dives are performed in zone 2 in a minimum of two different cave systems. These dives are intended to further develop the skills of the once cavern diver. Competencies are extended through exposure to more complex full cave diving techniques such as "jumps", "gaps", depth, limited decompression, increased distance, sump- and post-sump diving and the full use of accessible gas in a set of double tanks combined with a set of STAGE TANKS.

Emphasis in this course is upon dive planning and skill perfection through actual cave dives. Techniques learned through earlier courses are critiqued and expanded. The Cave Diver II course is not intended to prepare divers for evaluating all facets of cave diving. It is intended to expose students to different cave diving scenarios of dive planning and skill perfection. Although the student is introduced to more complex navigation techniques, students are encouraged to complete the next level of training before attempting complex dives.

Upon successful completion, the candidate will be qualified as a CMAS Cave Diver II (*Apprentice Cave Diver*).

Prerequisites: Cave Diver I CMAS *and* \*\* Diver or equivalent, 50 OW dives of which are 10 night dives, 4 cavern dives since CD I certification, valid medical

Duration: min. 2.5 days

Classroom: min. 4 hrs

Dives: min. 4

Caves: min. 2 different

Constraints: diver restricted to zone 2, double tanks only (no stages), no restrictions, no (post-)sumps, max. depth 30m

## **2.3 Cave Diver III (Full Cave Diver)**

(for detailed course content and prerequisites ref. to chapt. 9)

This is the third and final course in the standard cave diver development curriculum. Exposure to more sophisticated, demanding and complex cave diving scenarios is the foundation to "safe cave diving" at this level of training. The maximum depth for Cave Diver III level is 40m (EAD!).

### **Objectives:**

The Cave Diver III (Full Cave Diver) course is emphasizing advanced cave diving planning and execution. This is the final step in the progression from Cave Diver I (Cavern Diver) to Cave Diver III (Full Cave Diver). Techniques learned through earlier courses are more fully developed and refined, with the cave diver exposed to more sophisticated cave diving scenarios. Relatively few divers in the world achieve this level of advanced capability and training.

### **Content:**

If deemed necessary, an open-water evaluation and orientation dive is completed to review cave diving techniques (preliminary assessment). A minimum of eight cave dives are performed in zones 2 and 3 in a minimum of four different cave systems.

Participants will perform and participate in line gaps/jumps, circuits, traverses, "Y's and T's", decompression procedures, restrictions, and low visibility situations, sump- and post-sump diving and the use of stage tanks (up to 2). These dives are intended to bring together all aspects and facets of preceding training and experience. All limitations of the previous levels of training are withdrawn.

Upon successful completion, the candidate will be qualified as a CMAS Cave Diver III (Full Cave Diver).

# CMAS Cave Diving

---



## Standards & Training System

Prerequisites: Cave Diver II CMAS *and* \*\*\* Diver or equivalent, 100 OW dives of which are 20 night dives, 8 cave dives since CD II certification, Rescue Diver certification, valid medical

Duration: min. 5.5 days

Classroom: min. 8 hrs

Dives: min. 8

Caves: min. 4 different

Constraints: none (open for zone 3; incl. max. depth 40m / EAD ! )



## Standards & Training System

### 3. Specialty Cave Diving Courses and -Certificates

The detailed course contents and training programs are outlined in separate documents.

#### 3.1 Stage Tank Diving Specialty Course

(under development)

##### **Objectives:**

Stage Tank Diving is aimed at Advanced Open Water Divers *and* Cave Divers who wish to learn the special techniques of rigging one or more stage tanks with the necessary hardware and regulators. As already certified Cave Divers II are concerned, this course is intended to help develop the participant's skills and knowledge in extended penetration diving with the use of such stage tanks.

For this course all stage tanks may be filled either with air or EANx (for properly certified Nitrox diver) as required by the dive plan.

A minimum of two hours of theory is covered during this course and a minimum of four dives utilizing stage tanks in *various configurations* is to be performed. It is not necessary to execute these training dives in the true cave environment, even if this should be the preferred choice. However, it is strictly prohibited to enter overhead environment beyond the zone where a free ascent is guaranteed with divers who are not properly cavern/cave certified!

The practical part of this course should be done over a period of not less than two days.

**Note:** This course is strongly recommended for potential cave divers III (full cave divers) candidates. From 2006 on, the successful completion of this course will be a *compulsory* prerequisite or the Cave Diver III course.

##### **Content:**

Concentration is on practical application and experience. Longer dive exposure, decompression, safety practices and procedures, advanced gas management, stage rigging (different configurations with 1 or more tanks), trim, streamlining, problem management, tank depots, stage tank exchange, task loading, and psychological aspects are covered.

At least two hours of lecture to include discussion of motives, equipment, procedures, technique, task loading and decompression.

Prerequisites: \*\* Diver CMAS (Adv. OWD) or Cave Diver II or equivalent, valid medical

Duration: min. 2 days

Classroom: min. 2 hrs

Dives: min. 4

Constraints: restricted to zone 2 if performed in cave environment (with certified cave divers only!),  
max. depth always 30m

#### 3.2 Sidemount Diver

(under development)

##### **Objectives:**

This course is designed to expose the experienced cave diver to alternative cylinder and harness configurations when back-mounted cylinders are not appropriate or available. Though considerably more complex than standard back-mount diving, side-mount has clear advantages. Only the side mount cave diver is truly self reliant. But, the inherent gas management, trim and complexity of diving independent cylinders present a challenge to even the most experienced back-mount diver.

**Note:** This course is strongly recommended for Cave Divers III (full cave divers) who want to further extend their range of exploration towards small caves.

# CMAS Cave Diving

---



## Standards & Training System

### **Content:**

Safety practices, procedures, conservation, advanced gas management, equipment modification/philosophy, trim, streamlining, problem management, task loading, psychological aspects and how to build a "side mount rig" are all covered in this comprehensive program.

Prerequisites: Cave Diver III CMAS or equivalent, valid medical

Duration: 2.5 days

Classroom: 4 hrs

Dives: min. 3

Caves: min. 2 different

### **3.3 DPV (scooter) Pilot**

(under development)

DPV's (Diver Propulsion Vehicles) are a favorite piece of equipment to many cave divers. DPV's allows the cave diver to explore the cavern and caves in depth (extended penetration).

### **Objectives:**

The purpose of the DPV (Diver Propulsion Vehicle) course is to exposure the trained cave diver to the basic fundamentals of the safe operation of diver propulsion vehicles in underwater caves while under the direct supervision of a qualified DPV Instructor. The student is able to build practical experience in the field under controlled conditions.

Note: This course is strongly recommended for Cave Divers III (full cave divers) who want to extend their range of exploration (penetration distance)

### **Content:**

The two day DPV's (scooters) specialty course covers how to use scooters (DPV's) in the overhead environment with the use of safe gas-management rules, handling of reels, negotiating restrictions, silt passages, and dealing with cave conservation. There are practice emergency techniques involving inoperative scooters and out of air situations.

Safety practices, procedures and techniques common to most DPV's used in the unique environment of a cave are covered. Conservation considerations such as low impact operation are emphasized. Potential emergency situations are simulated and practiced.

There is at least four (4) hours of lecture to include:

1. The planning, organization, procedures, techniques, problems, and hazards of diving with an underwater propulsion vehicle (incl. electrical & mechanical advantages/disadvantages of DPV's).
2. Equipment considerations including but not limited to battery care, maintenance and precautions.
3. Gas planning and -management and team back-ups
4. General safety proper trouble shooting procedures for: determining a turnaround point, vehicle failure, runaway motor, descents and ascents and avoiding propeller entanglements.
5. Cave conservation and techniques to avoid harming fragile aquatic life.
6. Techniques for entering and exiting the water with a DPV

Prerequisites: Cave Diver III CMAS or equivalent, valid medical

Duration: 2 days

Classroom: 4 hrs

Dives: min. 3

Caves: min. 2 different



## Standards & Training System

### 3.4 Underwater Cave Surveying & Mapping

(under development)

This course is to be elaborated and offered in cooperation and under the patronage of the local speleological society/association.

#### **Objectives:**

This course is designed to provide the participants with the fundamentals of surveying underwater caves. It is intended to motivate more divers to survey caves, encourage the use of cave maps in dive planning, and increase the quality of published cave maps. Additionally, this course promotes standardization for all survey projects.

Note: This course is strongly recommended for Cave Divers III (full cave diver) who want to extend their expertise towards the more scientific aspects of cave diving.

#### **Content:**

The program material reviews early surveys and the development of standards and procedures. All phases of the survey process, from conception to completion of a survey, are discussed. Topics covered in full detail include accuracy standards, composition of a survey team, use and fabrication of special tools, survey techniques and methodology, safety considerations, data recording and mathematical calculations, symbols, cartography, and copyright and publication.

A minimum of one open water survey dive and three cave survey dives are performed over a period of no less than four days. A minimum of eight hours of theory is covered during this course.

Prerequisites: Cave Diver III CMAS or equivalent, valid medical

Duration: 4 days

Classroom: 8 hrs

Dives: min. 1 open water + 3 cave dives



### 4. Overview on CMAS Cave Diving Training- and Certification System

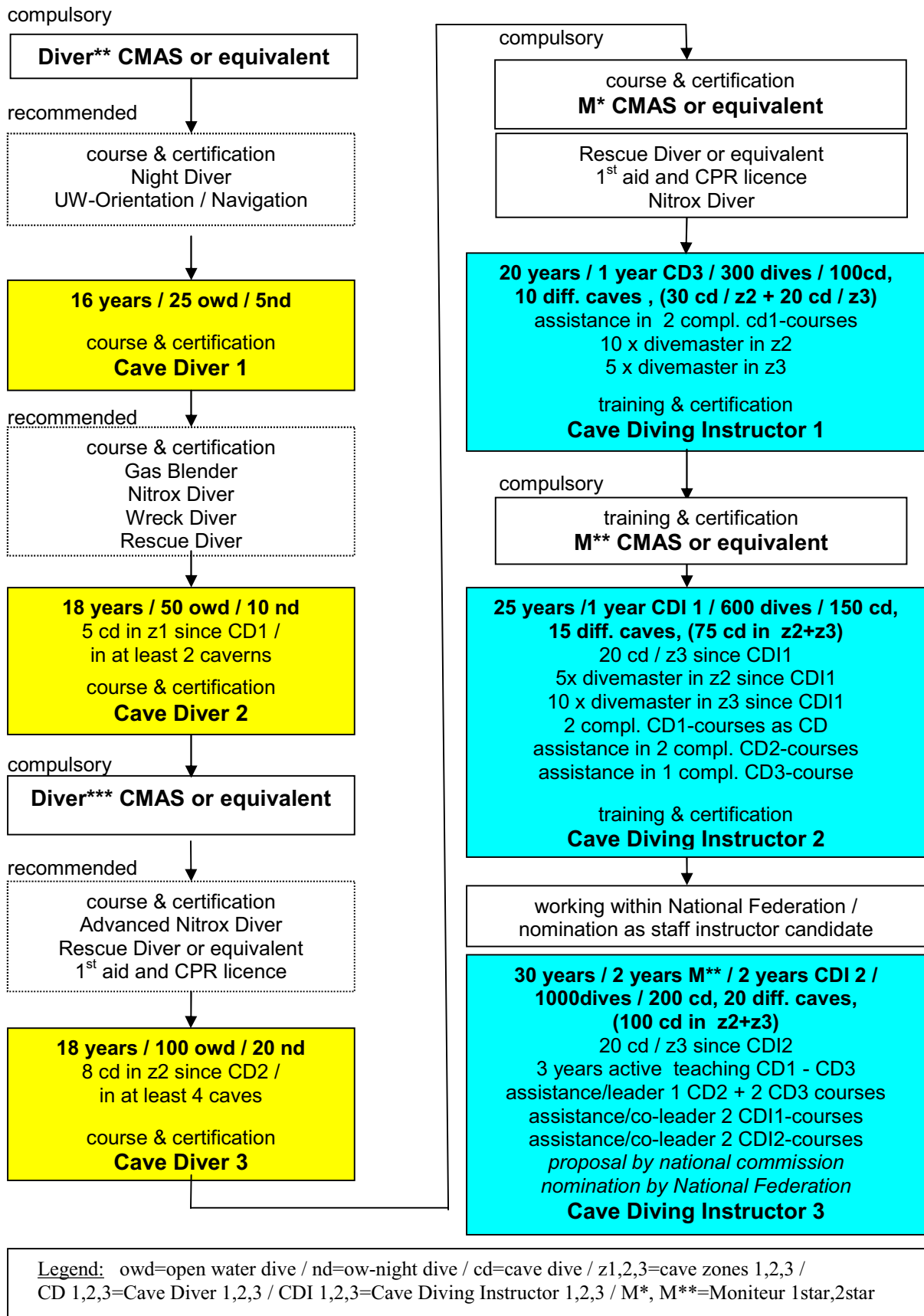





## **Part II:**

### **Cave Zones, Equipment and Safety Rules**



## Standards & Training System

### 5. Cave Zone 1 (daylight zone)

#### 5.1 Characteristics

This part is defined as the zone of the cave in the surroundings of the entry (cavern) and with the following characteristics:

- **direct visual contact and access to the water surface**, thus within the zone of natural daylight
- **no restrictions**: cross section area big enough for the **common passage of two divers** with their full equipment at the same time
- visibility of minimum **10m / 33ft**
- max. depth of **20m / 66ft**
- max. distance to the water surface of **50m / 166ft**
- **permanently** installed main line
- **no siphons (sumps), no sinks**, meaning **no current pointing inwards** or periodically changing direction
- **no bifurcations, no jumps**, the main line must never be left
- **no traverses** (no start at one point, exit at another one)
- **no gaps** (interruption of the line means aborting the dive and returning)
- **no circuits/loops** (return way must be the same way as during penetration)

#### 5.2 Specific equipment requirements

All related requirements as described in chapter "general safety rules, equipment & procedures" are also applicable and strictly to be respected.

- one member per group has to have a **second mask** (backup mask) for the group
- tank(s) w. total volume of min. **2000 bar\*liters** of air (e.g. 1x10 L /200 bar); mono-tanks acceptable
- 1 solid cutting tool (knife, cutter, scissors)
- 1 uw-slate and pencil
- 2 totally independent underwater lights (1 main lamp, 1 emergency/backup lamp) of which one (1) uses non-rechargeable batteries
- 1 safety reel per diver with at least **20m/66ft** of line
- 1 primary reel per group with at least **50m/166ft** of line
- helmets: ref. to "general safety rules, equipment & procedures"

#### 5.3 General remarks / required certification

- Penetration in this zone requires a specific training (CMAS Cave Diver 1 or equivalent) and a complete diving equipment for sport diving as a basis plus the additional required items under 1.3
- All activities take place during daylight and within the no-decompression times
- **In case that cavern diving activities take place beyond an official training course, but under appropriate guidance, it is highly recommended to use the equipment required for zone 2!**
- *This zone requires the level Cavern Diver as defined by other organizations such as NACD, NSS, PADI, NAUI, SSI, as well as CDAA (incl. Sinkhole Class 1).*

#### Cave Zone 1:

- Cavern Diver
- CMAS Cave Diver 1

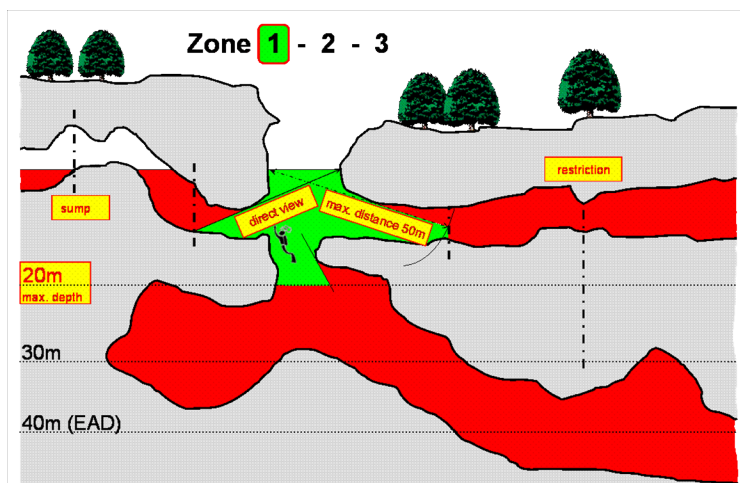



### 6. Cave Zone 2 (zone of complete darkness)

#### 6.1 Characteristics

It is defined as the zone beyond zone 1 with complete darkness and the following further characteristics:

- cross section area big enough for the **common passage of two divers** with their full equipment at the same time (**no restrictions, no squeezes**)
- max. depth is **30m / 100ft**
- visibility has to be **>3m / 10ft** but **<10m / 33ft**
- penetration is limited by the consumption of maximum **1/3** of the total initial gas volume without any deposit- or stage tanks included
- **no sumps, no sinks**
- a fixed permanent main-guideline *may* be missing

#### 6.2 Specific equipment requirements

All related requirements as described in chapter "general safety rules, equipment & procedures" are also applicable.

- every diver has to have a **personal second mask** (backup mask) at all times
- The minimum gas volume is **3200** bar\*liters gas (2x8L /200bar).
- One of the regulators must be equipped with a long intermediate pressure hose of approx. **2m / 6-7ft** length.
- 2 solid cutting tools (knife, cutter, scissors)
- 3 totally independent underwater lights (1 main lamp, 2 emergency-/backup lamps)
- 1 safety reel per diver with at least **20m/66ft** of line
- 1 jump/gap reel per diver with at least **50m/166ft** of line
- 1 primary reel per group with at least **100m/328ft** of line
- helmets: ref. to "general safety rules, equipment & procedures"

#### 6.3 General remarks / required certification

- Diving in zone 2 does no longer belong to the area of „normal“ recreational diving, but definitely to cave diving in the true sense of the word. In this zone it is very common to have dives with longer decompression stops.
- Water filled passages at the end of an otherwise dry cave or cavern do no longer belong to zone 2, because more than not they require special techniques and equipment for further penetration.
- *This zone requires the level (Apprentice) Cave Diver (without stage tank use) as defined by other organizations such as NACD, NSS, as well as CDA (incl. Sinkhole Class 2).*

#### Cave Zone 2:

- (Apprentice) Cave Diver
- CMAS Cave Diver 2

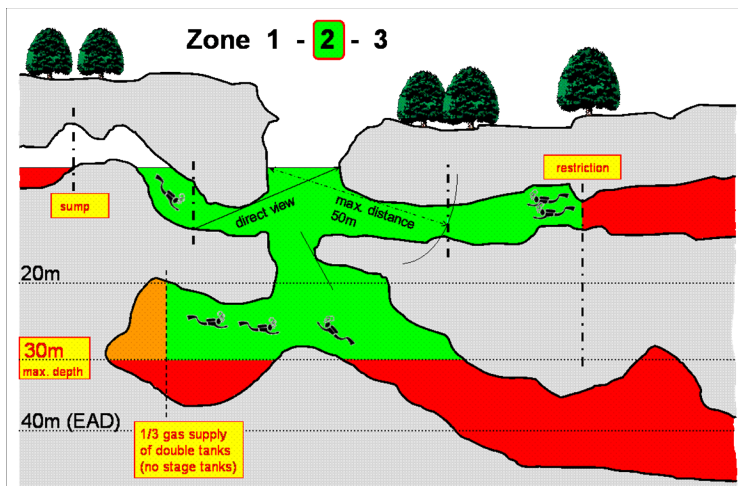



## Standards & Training System

### 7. Cave Zone 3 (highest competence level)

#### 7.1 Characteristics

It is defined as the zone which does not correspond to the criteria of either zone 1 or zone 2, mainly in the following points:

- distance (ref. also to initial gas supply under "general safety rules, equipment and procedures")
- visibility (< 3m / 10ft)
- depth (> 30m / 100ft but <=40m / 133ft [EAD!]); CMAS does neither recommend nor endorse diving deeper than 40m/133ft with compressed air
- type or passage: as soon as diving takes place **in more than just one sump** (air filled sections which require surfacing, sometimes even an in-cave decompression)
- **size of the cross sectional area (restrictions and squeezes)**
- as soon as **tank deposits** or **stage tanks** are used
- **as soon as Heliair, Heliox or Trimix is used**
- as soon as - regardless of the motivation – a **single diver temporary penetration** is carried out

#### 7.2 Specific equipment requirements

All related requirements as described in chapter "general safety rules, equipment & procedures" are also applicable.

- identical to those for zone 2, but further adapted to the specific goals of the planned exploration (e.g. deep diving, squeezes, long distance penetration)
- the minimum gas volume is **4000 bar\*liters gas (2x10L /200bar)**.
- 1 safety reel per diver with at least **20m/66ft** of line
- 1 jump/gap reel per diver with at least **50m/166ft** of line
- 1 primary reel per group with at least **100m/328ft** of line
- helmets: ref. to "general safety rules, equipment & procedures"

#### 7.3 Recommended additional equipment

Please refer to chapter "general safety rules, equipment & procedures / Application rules & procedures: Air- and Oxygen decompression stops".

#### 7.4 General remarks / required certification

*This zone requires the level Full Cave Diver as defined by other organizations such as NACD, NSS, or Penetration as with CDAA (incl. Sinkhole Type 3)*

##### Cave Zone 3:

- Full Cave Diver /
- Penetration (incl. Sinkhole Class 3)
- CMAS Cave Diver 3

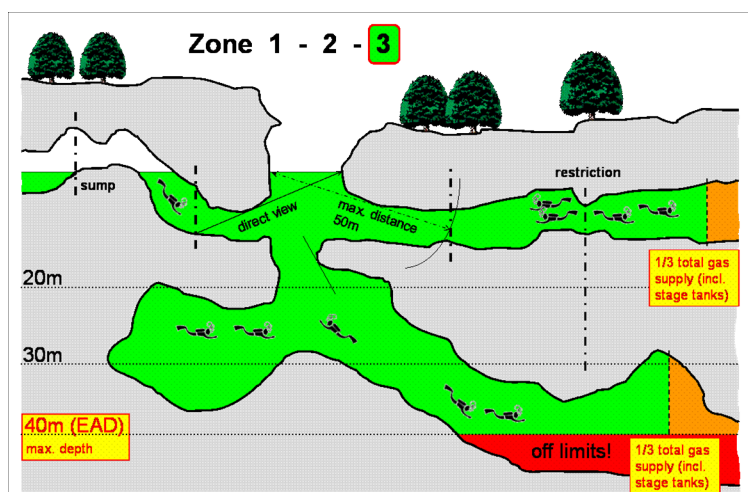



## Standards & Training System

### 8. Requirements for Divers and Equipment / Application- and Safety-Rules

The following requirements are an integral part of the whole CMAS training- and certification system. Whereas the bare standards (chapters 6-9 and 10-13) only define the prerequisites and the requirements for obtaining a certain certificate, all relevant requirements to equipment, application- and safety rules and constraints are described in this chapter here.

#### 8.1 Foreword / Introduction

- **Cavern** diving means that diving will take place in the entrance area of water-filled, natural or artificial cavities and in the zone with natural daylight.
- **Cave** diving means that diving will take place in water-filled, natural or artificial cavities and in zones beyond natural daylight (total darkness).
- The following rules apply to the self-dependent cave diver with no direct connection to surface installations.
- Knowledge and skills required for this type of diving exceed by far the common diving competences. It is absolutely compulsory to have a profound knowledge of the cave system, to be well trained in handling all required additional equipment and in the application of special diving techniques, as well as to have a very stable mental constitution.
- NO open water diving training - regardless how good it was - can prepare a diver adequately to the specific hazards, risks, and requirements of the overhead environment!
- *Disregarding one of the core rules concerning **air (gas) - line - light** will be automatically considered as negligence by CMAS.*

#### 8.2 Requirements to the diver

- Physical Fitness:
  - Diving requires for a certain level of physical fitness. This holds especially true for cave diving because here - due to the swimming distances, the weight of the equipment and even some climbing - the physical requirements are even higher.
  - For all CMAS cave diving courses the participant has to present a valid medical attest (not older than 1 year) on his/her unrestricted fitness to dive and to participate on all training activities. This attest has to be presented latest before the first water lesson.
  - In case the responsible course director has any reasonable doubts (or proven facts) on the physical performance of a participant, then he/she is strongly requested to control these prerequisites by making an assessment (ref. to Certification and to chapter Assessments). This assessment consists of the fin swimming exercise with full gear and breathing through the snorkel on the surface as described under chapter Assessments. If the candidate is unable to pass this test before the first open water dive of the course, then he/she is to be rejected from any further participation.
- Mental Stability and -Attitude:
  - Safe cave diving requires for a certain level of mental stability and for a non-aggressive mental attitude concerning cave diving-related activities. In case the responsible course director has any reasonable doubts (or proven facts) about the fulfillment of these prerequisites by the candidate, he is free to reject the candidate, or expulse him/her from the training course. However the latter can only be done after the candidate has not complied with the expressed request of the course director to change his attitude or gives definite proof of his/her inability to scope with these prerequisites.

#### 8.3 Permanent and temporary Installations in the cave

- The submerged part of the cave should be equipped with a state-of-the-art fixed main guideline. If this is not the case then the site will be automatically classified as zone 3.



## Standards & Training System

- It is highly desirable that this main line is marked in regular intervals with directional line markers, pointing towards the exit. It may also be useful to add small tags with the distance from the exit written on them (métrage).
- Special attention has to be given to both ends of this line, to the installation and its fixation to the walls of the cave.
- The first fixation point (primary tie-off) and thus the start of the main line must be fixed either
  - on land (shore zone) or
  - at a point underwater where the diver can ascend straight to the surfaceand in a way that it can not be easily reached by passers-by.
- The second fixation point (secondary tie-off) should be some 3-6m/10-20ft away from the first point. Its function is purely to prevent undue stress and tension on the first point and as a secondary line of defense in case the first tie-off loosens (or is loosened by someone).
- At jumps - especially at longer ones - a last tie-off should be made shortly before the new fixation point on the new main line (0.5 - 1m before) and from thereof the final end of the jump-line is to be placed in an almost rectangular way to the new mainline.
- Continuing Line Connection:
  - it's in every diver's own responsibility to always and everywhere establish a continuing line connection back to the entrance/exit of the cave. Violation of this rule will always be regarded as gross negligence.
  - in case the permanent line is broken somewhere, the diver has either to abort the dive and to return or to establish a temporary continuation by means of his jump-/gap-reel for this dive, or to repair the gap with his gap-reel.
- Line material and type (ref. also to chapter 1.3 and Appendix 8):
  - Line material for any kind of line must not rot while underwater, must not float (such as Polypropylene) and should not change its length itself too much or lose its mechanical properties while wet (Nylon is the preferred choice)
  - For some environment, it may even be advisable to use stainless steel wire.
  - Only braided lines should be used, not twisted one
  - Thickness for permanent main lines can vary from 2-4mm and with a breaking strength of not less than 1000Newton, depending on the cave conditions (e.g. currents) thus giving enough resistance against abrasion.
  - Colour should be white or strong yellow for permanent main lines and white for all others in order to be seen even in low visibility conditions
- Use of markers on a permanent mainline:
  - Basically, from the focus of usage, two different types can be distinguished: permanent markers (being fixed permanently on the mainline like traffic signs) and personal, temporarily used markers, attached by the diver for the duration of his dive and being removed on the way out.
  - From the geometrical form, 3 different types can be distinguished: Directional markers/line arrows (permanently *and* temporarily used), non-directional markers / line cookies and clothespins (both temporarily used only). Clothespins should be used with caution and only if there is no better alternative.

For the usage of these markers the following rules and recommendations apply:

- Marker should be used reluctantly with the least number possible and only at places with a high probability of otherwise orientation problems, preferably for circuits and traverses, at intersections, Ts and for jumps.
- Whenever possible only markers of one color (red, white, yellow) should be used within one cave by one diver.
- To avoid misunderstandings it is highly recommended to use markers of another color than the one used for the permanently fixed markers on the mainline in the cave just being explored.
- As material, a not too hard plastic should be used, in no case metal. There should be no sharp edges which will sooner or later cut through the line.



## Standards & Training System

- Markers should always be secured with a double loop on a line.
- In contrast to permanent markers, personal (temporary) markers should carry the initials of the owner in well readable writing.
- The mid-way point in a circuit or in a traverse passage should be marked with two arrows, pointing in opposite directions and being fixed 5-10cm from each other.
- At a bifurcation with an exit on each branch the closer one should be indicated with a pair of arrows pointing in this direction, the other one (which is farther away) marked with one single arrow only.
- Except for emergencies all personal (non-permanent) markers have to be taken from the line on the way back (no "dog-tags" to be left!).
- In order to avoid any confusion the joint between a jump line and a mainline should not be placed between a double arrow marking (mid-way point or closest exit).
- A marker should be fixed to the joint between the jump line and the mainline as a precaution against slipping sideways and in order to be seen well.
- For groups which will stay together partially only, each of the sub-formations must use their own reels and markers, totally independent of what the others do.

### 8.4 Requirements for personal cave diving equipment

The rules for required equipment follow the requirements of each zone and its characteristics, as each of these zones has its own special requirements.

- The general rules for ALL personal equipment are: **select only equipment which**
  - **is of good quality**
  - **is functional**
  - **is easy to use**
  - **is safe to use and robust**
  - **you are familiar with**
  - **fulfils exactly the intended tasks**
  - **is conform with all CMAS standards and requirements**
- Further CMAS General Guidelines for equipment:
  - Take only equipment with you that is appropriate for the dive you just carry out; everything else leave at home! Too often only, less is more.
  - However, the really important pieces of equipment must be carried with the required redundancy.
  - Within the cave diving environment, it is important to have a most streamlined outer profile.
  - If ever possible, there must not be any obstructive or dangling pieces of equipment, which can easily get caught from and entangled in the guideline.
  - **The cave diver has to select his equipment configuration from the focus of a complex system, in which every module has to harmonize with all others or at least no piece must notice ably restrict any other piece in its functionality. As a cohesive and carefully arranged unit, it has to facilitate the dives and must be configured so as to provide the greatest support.**
- Instructor's Equipment:

During all CMAS training courses a CMAS cave diving instructor has to be equipped according to zone 3, regardless of the course level or actual zone.

In any case, each cave diver must carry the following equipment:

- Fins, mask(s), adequate protection against cold (wet- / dry-suit); NOTE: CMAS does NOT request the compulsory use of dry suits. It is in the responsibility of each diver to choose an adequate thermal protection. However, for longer or deep dives, cold continental water temperatures and specially when using Trimix, a dry suit is highly recommended.
- Backup mask
  - In zone 1, it is compulsory that at least one (1) of the team members, preferably the team leader, has to have a backup mask. It should be tested before the dive that the mask fits every team member reasonably. All divers of the team MUST know who carries the backup mask (-> briefing).



## Standards & Training System

- In zone 2 and 3, it is compulsory that every diver has to have his own personal backup mask
- 1-2 (depending on the zone) solid cutting tools (knife, cutter, scissors), secured against dropping with a safety lanyard
- Line material and type (ref. also to chapter 8.3 and Appendix 9):
  - Concerning parameters such as type of material, resistance against rotting, type of webbing, the same holds true as outlined in chapter 1.2
  - Thickness for non-permanent primary-/safety-/gap-/jump-reels may vary from 1.5-3.0mm because of its temporary installation use; requirements for physical strength and resistance against abrasion are lower than for a permanently installed main line
  - Colour should be white in order to be seen even in low visibility conditions
- Line reels:
  - Cavern Zone (zone 1): every diver has to have at least 1 personal safety-reel
  - Zone 2 and 3: every diver has to have at least 2 personal reels (1 safety-reel, 1 jump-/gap-reel or -spool, line length corresponding to the zone)
  - 1 primary reel per group has always and in all zones to be carried with a line length corresponding to the zone
  - If, due to the actual on-site conditions the responsible instructor in charge feels it to be necessary, he is free to rise the requirements for a specific dive with regard to number and types of reels to be carried with, as well as line lengths and thicknesses.
  - Materials used must be corrosion proof
  - Construction must be so that the line (if getting loose) can not block the drum
  - For reels with a handle, it must be made sure that the handle may not get entangled with a line
  - Reels should be clearly marked with the owner's name in good readable writing
  - Length of line on the reel should also be indicated in the same writing

- Required line lengths:

	zone 1	zone 2	zone 3
safety-reel or. spool	20m	20m	20m
jump- or. gap reel	-----	50m	50m
primary-reel (per group)	50m	100m	100m

- Line markers:
  - Each diver -regardless of the zone - has to carry a reasonable set (min. 3 of EACH type) of directional line markers (arrows) AND non-directional markers (line cookies, cave cookies) ready for use.
  - All markers should be personalized with the initials of its owner in good readable writing.
- Regulators:
  - It is strongly recommended to only use regulators which are EN250 certified (this European norm is worldwide accepted as standard for regulators).
- Instrumentation (minimum):
  - Adequate instrumentation but at least 1 dive computer or dive table with watch and depth gauge
  - Dive computer should be adaptable to those gas mixtures actually used; if not, decompression stop times for air diving must be observed
  - At least 1 submersible compass with analogue display
  - At least 1 submersible pressure gauge per tank (ref. to tank monitoring)
  - Because of the easier reading even in total darkness an analogue display with self-luminous background is to be preferred.
- Buoyancy compensators:
  - Each diver has to be equipped at all times with a buoyancy compensation device (jacket, wings) of adequate lifting power (but with a volume of not less than 20 liters when fully inflated) and corresponding to the weight of the equipment.





## Standards & Training System

- CMAS does NOT request the compulsory use of wings; if jackets of standard design also have the requested features, they may be used as well.
- Considering the harsh treatment of cave diving gear, the use of a type with inner bladder and an outer protective shell is highly recommended.
- (Power-)Inflators:
  - All buoyancy compensator devices (jackets, wings) and dry suits must be equipped with power inflators, connected to the 1st stage of a regulator.
  - Power inflator for buoyancy compensator and that for dry suit must not be connected to the same regulator 1<sup>st</sup> stage.
  - For Trimix and long duration dives it is highly recommended to use Argon from a separate bottle for the inflation of the dry suit in order to avoid problems associated with isobaric counterdiffusion and thermal conductivity and related body heat loss.
- Tanks / Tank Size / Filling Pressures:
  - All tanks used during CMAS cave diving training courses have to carry a valid (meaning not overdue) stamping of the visual inspection or of the hydro test by an authorized inspection authority or -company from the participant's country of residence or of the country where the course takes place.
  - Tanks with overdue testing- and acceptance dates must not be used during CMAS cave diving courses.
  - Single tanks are permitted in zone 1 only
  - From zone 2 on, at least 2 completely independent tanks of equal capacity have to be used *or* 2 connected tanks but with an isolator valve in between in order to make it possible to isolate one defective tank or regulator
  - Minimum tank sizes are defined according to the relevant zones
    - \* zone 1: single tank allowed, min. 2000 bar\*liter (e.g. 1x10l / 200bar)
    - \* zone 2: double tank set, min. 3200 bar\*liter (e.g. 2x8l / 200bar)
    - \* zone 3: double tank set, min. 4000 bar\*liter (e.g. 2x10l / 200bar)
  - One exception accepted by CMAS with regard to minimum tank size is for scientific oriented exploration in very confined parts of a cave (zone 3) where tank size has to be determined according to cave size and not vice versa.  
However this type of diving is no more part of the recreational cave diving.
  - If, due to the actual on-site conditions the responsible instructor in charge feels it to be necessary, he is free to raise the requirements for a specific dive with regard to the gas volumes to be carried with and the number of additional stage tanks.
  - Minimum size for stage tanks is 1400 bar\*liter (e.g. 7l / 200bar)
  - From a penetration distance of **500m/1500ft** or more without the possibility to re-surface, a **3<sup>rd</sup> tank** has to be carried with (stage tank, 3 tank rig) with a minimum capacity of 1400 bar\*liters (e.g. 7 litres/200bar).
  - Steel tanks with a size of more than approx. 15l are not recommended by CMAS for recreational cave diving, partly because of their weight and bulk, partly because of trim- and buoyancy problems associated, including the danger of capsizing.
  - For the same reasons 300bar/4500psi steel tanks are also not recommended
  - Minimum size for O<sub>2</sub>-tanks on decompression stops is 800 bar\*liter (4l/200bars)
  - For any additional tanks for the decompression stops there no specific rules with regard to size, except one: the total amount of gas must be sufficient to last for all required stops.
  - Tanks with working pressure ratings below 200bar / 3000psi should no longer be used
  - For the sake of additional redundancy it's always better to distribute the gas volume to some tanks more but of smaller size than using some tanks less but of bigger size.
  - Indicated working pressures, legal allowances for overfilling (if any) and on-site legislation must always be strictly observed
  - To simplify the calculation of the thirds it is recommended that all divers within a group use tanks sets that contain about the same amount of gas.



## Standards & Training System

- Caution when using mixed gases:
  - \* It is strictly prohibited to fill different gases in a twin tank set if the tanks are connected with a bridge.
  - \* It is also strongly recommended not to fill different gases in a independent back mounted double tank set.
- Tank valves & manifolds:
  - All tank valves used, be it for single- or for double tanks, must be configured in such a way (with special emphasis on the position of the valve knobs) that the diver is capable to carry out a shutdown-drill within reasonable time on his own and without the help of a partner and without being forced to take off the tank set.
  - The only valve type allowed is the **DIN** type. INT-yokes are strictly prohibited.
  - In all zones only valve types are permitted that allow each outlet to be closed/opened separately and independent of the others.
  - In zone 1 and while using single tanks, a valve with 2 separate outlets has to be used (either Y- or H-type). An octopus regulator configuration (1 first stage with 2 second stages) is NOT acceptable. A submersible pressure gauge (SPG) must be connected to one of the regulator rigs.
  - Any free/unused manifold openings on the tanks used underwater are highly undesirable and must be closed with an appropriate metal screwed-in plug. Free openings and plugs fabricated from *other* than appropriate metal material are strictly prohibited.
- O<sub>2</sub>-Compatibility of tanks, valves and regulators:
  - Up to a content of 40%O<sub>2</sub>, no special manifolds or valves are requested
  - Inner walls of the tanks, manifolds and valves and the regulators have to be 100% O<sub>2</sub>-compatible according to the corresponding regulations and laws. This is the task of the user (cleaning, use of correct grease). Each user carries the full responsibility alone. This holds true even more if pure O<sub>2</sub> is decanted during the blending process !
  - All maintenance and trouble shooting of regulators and all other personal equipment is in the sole responsibility of each diver.
- Reserve mechanisms:
  - Mechanical reserves of all kinds are strictly prohibited.
  - The permanent control of the tank pressure has to be done with a submersible pressure gauge (SPG) with analogue or digital display (ref. to tank monitoring).
- Helmets:
  - a) are *compulsory*, as soon as *dry passages* (sump/post-sump diving) have to be followed, during *climbing* or if *scooters* (DPVs) are used and during *rescue training* of all kind
  - b) are *highly recommended* in *strong currents*, *low visibility* less than 3m/10ft, *low passages*, cross section areas with *obstructions* (rock needles etc.) and during all kind of *line installation-* and *surveying/mapping activities* (manual work).
  - Helmets should be of lightweight design and of corrosion-proof material (plastics), should not (or only minimally) reduce the field of vision and the freedom of head movement and should give adequate mechanical head protection
  - CMAS does expressively not recommend any specific type. All types of outdoor-activities such as ice-hockey, climbing, biking, canoeing, caving, construction, fulfilling the aforementioned criteria will be fine.
  - If lamps (primary or back-ups) are fixed to the helmet, it is recommended to use a fixation which allows turning the lamp thus eliminating the danger of blinding partners.
  - If for the sake of weight reduction or technical simplicity a fixation with no turning possibility is used, a clip-on type is to be preferred over a fixed one, so the lamp can be easily taken away from the helmet or put on whenever needed with one hand and no tools.
  - If, due to the actual on-site conditions the responsible instructor in charge feels it to be necessary, he is free to require carrying helmets for all kind of activities, including those for which CMAS standards only recommend the use of helmets.



## Standards & Training System

- Lighting systems:
  - Technically speaking it is the required luminous flux (in lumen) that has to be reached, regardless of the technology behind. The additional reference to conventional Halogen power is only used because every diver has a clear understanding what to expect of a "30W Halogen lamp" (as an example).
  - Definitions
    - \* Two or more lamps being connected to a *common, single* battery pack or container are regarded as one (1) *single* system!
    - \* The term "main lamp" will be used for a lamp which is suitable to give the diver the usually expected visual comfort, meaning to illuminate sufficiently the cave passage in its entirety or parts thereof over several meters.
    - \* The effective 100% light output (luminous flux) of a so-called main lamp must be at least 700 lumen (equivalent to the output of a conventional 30W halogen lamp). The available capacity (burning time) must at least be 50% more than the planned duration of the dive, but never less than two (2) hours.
    - \* The term "backup lamp" however is used for a lamp which will be used as a substitute after the main lamp has failed and with a luminous flux which is just sufficient
      - a) to illuminate the cave passage ahead of the diver in close proximity of the cave line over a distance of 1 to 1.5m, allowing the diver to swim cautiously towards the exit
      - b) and which can be used to clearly give and correctly interpret signals.
    - \* The effective 100% light output (luminous flux) of a so-called backup lamp must be at least 90 lumen (equivalent to the output of a conventional 4W halogen lamp). The available capacity (burning time) of such a backup lamp must be at least equal to the planned duration of the dive, but never less than two (2) hours.
    - \* capacity: the term available capacity (burning time under 100% output) is expressively used for the capacity resulting of the actual charging state of batteries and accumulators immediately before the planned dive.
  - ***The following numbers of required lamp systems and their required performance data have to be regarded as minimum that must never be unterschritten. Any infraction of this rule will be judged by CMAS as negligence.***
  - ***CMAS leaves it to the discretion of any particular diver to carry more lamps than the number specified here as a bare minimum, as long as he/she can handle this additional equipment without undue stress.***
  - If, due to the actual on-site conditions the responsible instructor in charge feels it to be necessary, he is free to set higher requirements concerning number of lamps, power output (luminous flux) and burning times.
  - Zone 1:
    - \* **Minimum 2 totally independent light systems must be carried at all times: one (1) main lamp, one (1) emergency/backup lamps as per CMAS definition.**
    - \* at least one (1) of the two (2) systems has to use non-rechargeable batteries
  - Zone 2 and 3:
    - \* **Minimum 3 totally independent light systems must be carried at all times: one (1) main lamp, two (2) emergency/backup lamps as per CMAS definition.**
    - \* at least one (1) of the three (3) systems has to use non-rechargeable batteries
  - Long distance and -duration dives: for such cave dives which exceed the capacity of currently available single systems, the diver has to carry as much additional systems (main lamps and backup lamps) that
    - a) the total available capacity of all main lamps together is at least 50% longer than the planned duration of the dive (but minimum 2 hrs for each main lamp).
    - b) the total available capacity of all backup lamps is at least equal to the planned duration of the dive (but minimum 2 hrs for each backup lamp).
  - ***Attention when using DPVs/scooters:  
When using DPVs (scooters), two (2) main lamps with the defined performance data as mentioned above are required as soon as diving takes place in zone 2 or 3.***



## Standards & Training System

- **Attention during push dives alone:**  
**During push dives according to the definition of CMAS, two (2) main lamps with the defined performance data as mentioned above are required as soon as diving takes place in zone 2 or 3.**
- It must be possible to carry the lights in a way that both hands stay free for any manual activities (all fingers of the holding hand must be completely free for any manual work).
- Lamps with an output of more than that of a comparable 50W Halogen lamp are not recommended by CMAS for the 3 following reasons:
  - a) danger of blinding other team members
  - b) it's only too easy to "cover" the signals of another team member with such strong beams so communication may become difficult
  - c) because battery tanks are limited in size, it is not unusual for very strong lamps that their battery capacity (burning time) is compromised
- At the present state of the technique, LED lamps are not accepted als main lamps. Reason: the relatively low permeability of the LED beam in silty waters or otherwise stirred up sediments. This policy may be subject to change with the ongoing technical development.
- With a lot of suspended particles in the water, wide angle reflectors are not suitable. In such situations it is recommended to use spot reflectors.
- Hardware for attachments (carbines, bolt snaps, clips):
  - Straight action bolt-snaps are to be preferred over conventional clips/hooks or carbines.
  - Especially in salt-water, stainless steel (V2A, V4A) as material is to be preferred over brass.
  - Size has always to be big enough for handling with thick gloves.
- Rebreather:
  - Rebreathers may only be used if the user has received and can prove adequate training (specialty course) for this specific type
  - Such specialty courses are not part of the standard CMAS cave diving training
  - If rebreathers are used, it is compulsory to have adequate system redundancy (2-times, even 3-times redundancy, bail-out bottles)
  - Depending on the circumstances, additional tanks have to be stored underway so that even in an extreme emergency the diver is able to swim back with an open circuit system
  - The commonly used partial pressure limits for the different breathing gases (O<sub>2</sub>, N<sub>2</sub>, He) have to be observed as well
  - Within the framework of the standard CMAS cave diver 1 to cave diver 3 training program the use of rebreathers is not allowed.
- Scooter (DPVs):
  - In some countries/waters the use of scooters is restricted or even prohibited. It is in each divers own responsibility to gather for corresponding information. Such regulations must be strictly observed.
  - CMAS strongly recommends to use or to let use DPVs only if the user can prove adequate training (specialty course) in the correct use and handling for this specific type
  - Such specialty courses are not part of the standard CMAS cave diving training
  - Scooters should be used very reluctantly (on the grounds of safety- and environmental considerations) and only
    - \* if the goals are truly of scientific value (exploration of new passages) *or*
    - \* safety related tasks must be undertaken (laying new permanent mainlines, repair of gaps, „cleaning“ from superfluous lines) *and*
    - \* if such goals can not be reached by other means
  - Scooters should not be used in silty passages and in tight areas (restrictions, squeezes)
  - CMAS does not endorse the use of scooters „just for fun“ in the cave environment, especially by divers who are not properly trained in the safe handling of such vehicles. The danger of damage to the cave environment, of imposing a threat to other cave divers being present in the same cave is too big to justify an unrestricted usage.
  - Under no circumstances should scooters be used to make up for any physical deficiencies of the divers



## Standards & Training System

- When using scooters the rule of thirds MUST NEVER be used. More restricting rules such as 1/5 or even 1/6 must be applied.
- To guarantee the safe return in case of a failure of scooter:
  - \* either additional tanks must be deposited underway (or stored at strategic points during preparation dives) or
  - \* per 2 scooter drivers at least 1 additional backup scooter must be used, except for penetration distances that can be covered by swimming with the available gas volume
  - \* depending on the actual situation and further specific requirements (safety requirements, tricky currents etc.) the two alternatives may also be combined
  - \* a safety tank has always to be carried with (min. volume: 7liters/200bar) which will not be deposited underway and which will not be accounted for in the total gas volume
- The long hose must have a length of between 2.40 - 3.0 m to enable two DPV pilots to drive in a single file one behind the other in a gas-sharing situation.
- In case the diver has to swim back on his own power or the way back to the entrance has to be carried out at lower speed than planned the corresponding additional decompression gas has to be ready.
- As a rule of thumb, battery capacity of each of the scooters driven underway, should not be used to more than 35-40% for one way (penetration / return), thus in total to not more than 70-80%. The remaining capacity should be kept as an "iron" reserve for unforeseen events. The backup-/emergency scooter(s) are only to be used in case of a failure of another vehicle and remain unused otherways.
- For longer dives, exceeding this limit for a single scooter, the diver has to take so many additional scooters with her/him that the aforementioned limits will never be exceeded.
- These backup-/emergency scooters must never be deposited along the way, but must always be kept with the divers.
- For one specific dive every diver for himself should only use scooters of identical battery capacity (range) thus scooters can be exchanged easily without logistical problems.
- Driving with scooters without helmet is regarded as gross negligence by CMAS.
- The DPV pilot has to wear a harness, which enables him to be towed by the scooter via a towline. As a basic rule, no pulling forces must be transferred over the diver's arms.
- The scooter itself must be equipped with a second, stronger towline which is to be used in case another defective scooter must be towed back.
- The scooter must also be equipped with a "dead-man's handle", killing the engine instantly in case the pilot accidentally falls from the scooter.
- Within the framework of the standard CMAS cave diver 1 to cave diver 3 training program the use of scooters is not permitted

## 8.5 Application rules and procedures for use

- Classroom lectures:
  - A classroom lecture has a minimum duration of 45 minutes.
  - A break has to be made at least every 2 hrs.
- Training dives:
  - A training dive in the cavern area (zone 1) must have a minimum duration of 20 minutes.
  - A training dive in the cave (zone 2) or full cave area (zone 3) must have a minimum duration of 30 minutes.
  - A maximum of 3 training dives (within the no-decompression limits) per day may be done in the cavern area (zone 1), with adequate surface intervals.
  - A maximum of 2 training dives per day is permitted in zones 2 and 3, with adequate surface intervals.
- Admission of potential course participants:
  - No participant may be accepted for any practical water work and for any training dives if his/her equipment does not fulfill the CMAS standards and requirements by 100%. The enforcement of this regulation is totally in the responsibility of the cave diving instructor on site and in charge for the said water work.



## Standards & Training System

- Presence of instructors:
  - During all training lessons, whether classroom or water work, a CMAS cave diving instructor of the required level and in active teaching status has to be personally present on-site. The presence of an assistant or an instructor candidate alone is not sufficient.
  - This rule does NOT apply for guided diving of already certified cave divers.
- Security on land:
  - Whenever possible a qualified person staying on land should be nominated as support person / security officer
  - Should there be no such person available then the responsible dive leader/group leader should at least inform another trusted person about the planned activities and the governing parameters (especially the planned starting and termination times as well as the latest time for calling back)
  - In some countries the presence of such a qualified security person is requested by law. It is in the duty of the responsible organizer to gather the corresponding information in due time.
  - Responsibilities and tasks of this security officer:
    - \* stays in closest vicinity (at shouting distance) of the cave entrance or the pond to be able to take immediate and appropriate action in case this is needed
    - \* has a geographical map of the area with official coordinates available
    - \* has a list with all involved persons on-site, of all divers (dive roster) and their group assignments as well as all relevant parameters of the dives such as starting time, planned penetration, planned max. depth, duration, used gases incl. those for decompression
    - \* must be present in the pre-dive briefings and post-dive debriefings
    - \* must possess all relevant documentation such as emergency-checklists, list of mobile telephone numbers of other related groups or colleagues in the neighbourhood, emergency numbers of police, fire fighters, cave diving rescue squads or any further, local rescue organisation
    - \* must have access to all necessary equipment (1st aid box, oxygen etc.) as well as to parked cars of the team and must be able to seek for help with those vehicles in case this is impossible with mobiles and wireless communication
    - \* must be able to respond correctly to questions asked by on-site checks by authorities.
    - \* assures that lines fixed to points which are accessible from the shore will not be loosened or removed by unauthorized people.
  - Qualifications of the support person on land:
    - \* should know the geographical area and understand and speak the language of the country
    - \* should at least have a basic qualification in non-professional medical 1st aid. Formal training and certification in administering CPR is desirable.
    - \* must be able to correctly and efficiently use the rescue material available on-site.
    - \* must be familiar with the peculiarities of diving (incl. a basic understanding of the "classical" diving accidents and corresponding treatment) and with general 1st aid measures.
  - If requested by law or local ordinance start and termination of the dives must be communicated to the authorities concerned.
- Buoyancy control and trim:
  - Perfect mastering of buoyancy control is one of the basic prerequisites of cave diving and must be mastered before any cave diving training.
  - Basically, in horizontal caves it's more dangerous to be underweighted than to be overweighted. As a consequence, one of the primary rules of open water diving that the diver must be able to remove his weights has no validity in cave diving.
  - The amount of weight is to be selected so as at the end of a dive the diver can properly maintain his depth without undue stress at the 3m stage. If necessary the diver has to deposit so-called clip-on weights which can be fixed easily to the belt or a D-ring.
  - The diver has the free choice where and how to fix his weights. CMAS expressively does whether require nor recommend a specific configuration.  
However, the following general guidelines have to be observed:
    - \* weights are to be secured so that they cannot be dropped unintentionally
    - \* a good trim is of paramount importance and a must (whether prominently head- nor feet weighted)



## Standards & Training System

- \* „luminous lead“ is the preferred choice, meaning battery canisters serve very well also as weights
- \* weights should be carried and fixed in a way that they cannot get entangled in a line
- \* weights are to be carried in a way that the diver is not restricted in his movements and the weights are not creating any painful pressure point. This is of special importance during negotiation of dry passages.
- The configuration that the whole weight is fixed onto the tanks or the backplate respectively, may create a serious problem in situations where the diver has to ditch - regardless of the reasons do to so - his tank with the backplate, especially in shallower waters.
- In caves with dry passages, where tanks have to be ditched and transported separately, weights directly fixed to them are less suitable.
- Group-/Team size:
  - Group size must always be determined according to actual on-site circumstances, especially with regard to the requirements from cave environment, individual qualification levels and skills and planned activities.
  - Considering gas supply in emergencies, a group size of 2 divers only is not favorable.
  - Groups with more than 6 members are to be avoided!
- Team Order:
  - The general rule is: the group leader (instructor, divemaster, guide, etc.) is the first one to swim in and the last one to swim out (back). An automatic exception from this rule holds true for circuits and traverses.
  - For groups composed of divers of the same certification level
    - a) the one who knows best the cave or
    - b) if nobody knows the cave the most experienced cave diver among them should take the lead of the group
  - Diver with lesser experience or lower certification level should be positioned in the middle of a group
  - Whenever possible the last diver in (= the first diver out) should also be a diver of a higher skill- and experience level
  - In case a line is being placed it is the responsibility of the leading diver who is to be assisted by the following buddy (keeping line under tension, control of placements and wraps, correct laying out, illumination of passage etc.). On the way back it is the task of the last but one diver to loosen the line from such fixation points, to illuminate the passage without disturbing the last diver and to hold permanent visual contact to this buddy, while this one rolls up the line.
  - (Primary) light failure of a team diver
    - a) group of 2 divers: the corresponding diver swims back as first one ahead of his partner, while that one tries to illuminate the passage in front of the leading diver.
    - b) group of 3 or more divers: the corresponding diver will be positioned at second place
  - Out-of-air situation of a team diver or other gas-sharing situation
    - the donor together with the air receiving diver will always swim back at the head of the group, setting the pace, while the rest of that group tries to illuminate the passage in front of these leading divers
    - Depending on the size of the passage, the receiving diver swims either *besides* the donor (with touch-contact) or ahead, *but never behind him*.
- Negotiating jumps (ref. also to chapter „continuing line connection“):
  - All jumps, even if they are very small ("visual jumps") are only crossed with the own temporary jump-line
  - It must be made sure that the starting point on the main line and the fixation on the new permanent line are well secured against slipping sideways.
  - It must be also guaranteed that the new fixation is well marked visually or (in zero visibility) can be easily felt thus reducing the chance of being passed over by mistake.
  - At the starting point of the jump-line from the main line, the direction to the exit has to be clearly marked with an arrow (or a non-directional marker which is positioned on the exit side of the connection)



## Standards & Training System

- Gas partial pressures:
  - Should the dive take place in a country with any kind of diving legislation (e.g. partial pressures of different gases, max. depths, etc.) one must strictly abide.
  - If such legal constraints are missing, CMAS *recommends* the following limits with regard to partial pressures:

pN <sub>2</sub> max	≤ 4bar;	
pO <sub>2</sub> min	≥ 0.18bar ≥ 0.20bar	no work, short dive times with work, longer dive times
pO <sub>2</sub> max	≤ 1.60bar	good conditions, warm water, no work, short dives, during decompression at 6m and above
pO <sub>2</sub> max	≤ 1.4bar	cold water, work, currents, longer dives
pHe max	≤ 10bar	

  - The actual dive conditions may call for a further reduction of upper values.
- Tank markings (EANx, O<sub>2</sub>, Tmx):
  - All tanks that may be deposited somewhere in the cave during the dive have to be clearly marked with the name of the owner
  - O<sub>2</sub> tanks must be stamped accordingly; colour of outer wall according to legislation and must carry a good readable writing ("O<sub>2</sub>"/"Oxygen"/"Sauerstoff")
  - All tanks containing other gases than air must carry a good readable tag with the following indications:
    - \* type of gas (EANx, Tmx)
    - \* O<sub>2</sub>-fraction in % for Nitrox; fractions of O<sub>2</sub> / N<sub>2</sub> / He for Trimix. This analysis has to be done by the blender after the blending process is finished and once more at the dive site by the diver
    - \* Maximum Operation Depth (MOD) in meter (m) or feet (ft) with indicating the used units
    - \* Minimum Operation Depth (MinOD) in m/ft for Tmx with indicating the used units if a mixture is used with its O<sub>2</sub> content less than that of air (<20.8%)
    - \* [optional: EAD (Equivalent Air Depth)]
    - \* date of filling/ date of analysis
    - \* signature of the blender / tank owner
  - In addition to this easily removable tag, it is recommended to write the MOD in big size numbers (approx. 8-10cm / 3-4 in.) directly on the tank

**Caution: Before any tank measurements are made, oxygen analyzers have to be calibrated twice: once with normal air and a second time with pure oxygen (100% O<sub>2</sub>).**
- Tank valves/outlets of unused tanks:
  - Tanks which are carried with a mounted regulator set and which are deposited later, the second stages should be held under pressure but the tank valves be closed. Thus, two goals can be achieved: a) the system's gas tightness can be checked at any time and b) any entry of water is impossible.
- Tank rigging (harness):
  - The way of how to carry the tanks (back mounted double, back mounted triple, side mounted, and stage rigging) is dependent of the specific requirements of the cave, of the planned diving activities and to a lesser extent, personal preferences.
  - **There is no "CMAS-rule" of how to carry tanks.** In view of the various requirements from the different cave environments and the planned activities, such a rule would not be reasonable.
  - Especially in tight spaces it is recommended that the attachment of such tanks via bolt snaps and D-rings to the body of the diver should contain a flexible link (rubber, small cord/rope, O-ring, bungee cord etc.), so that in an emergency this connection can be quickly separated with a cutting tool.
- Tank pressure monitoring:
  - General rule: every diver must be able to visually check and monitor the content (=pressure) of all his attached tanks at any time, under any circumstances and instantly.





## Standards & Training System

- An independent submersible pressure gauge (SPG) with either analogue- or digital display must be connected to each tank in use underwater. Regardless whether this tank is carried by the diver himself or is deposited somewhere, whether the valve is open or closed or an isolator valve is used or not.
- Because of the easier reading even in total darkness an analogue display with self-luminous background is to be preferred.
- A dive computer with a tank pressure sensor for air-integrated calculations and a display of the measured tank pressure is also accepted as a pressure gauge.
- Regulator-and pressure hose marking:
  - All regulators and pressure hoses have to be marked with different colours (adhesive tape) so that a rapid and safe identification (valve - manifold - 1<sup>st</sup> stage - hose - regulator 2<sup>nd</sup> stage) is guaranteed even under low visibility conditions.
  - To avoid any mismatch and if gas mixtures other than air are used and in low-visibility circumstances, each regulator *should* carry a well readable tag in the area of the second stage (on hose or ev. on 2<sup>nd</sup> stage casing) on which the gas type (EANx, Tmx) and its MOD is written.
  - To clearly distinguish the different gas mixtures used during the dive, not only **MUST** all tanks and regulators be properly tagged as indicated above, but for each mixture, another distinctive and easy to distinguish colour should be used (colour of the adhesive tape used for tagging).
- Gas management rules:
  - For groups consisting of only 2 divers or whose members have different initial gas volumes in their tanks it is *compulsory* to apply the so-called „modified rule of thirds“ if not an even more stringent rule is applied. With the „modified rule of thirds“ the smallest third (or an ever smaller volume) of the initial gas volumes of all team members is calculated first and used for determination of the individual "return pressure" for each diver.
  - The application of this modified rule of thirds is also *strongly recommended* for groups bigger than just 2 divers.
  - For diving in unknown caves or caves the divers are not familiar with, for exploration dives of any kind, for groups with a relatively low level of expertise and for caves with known "problem zones", it is strongly recommended to apply a more restricting rule than the rule of thirds (e.g. 1/4 of even down to 1/5).
  - It is strictly forbidden and may even be deadly to apply the rule of thirds for caves with a current going inwards (into the cave). The same holds true if DPVs are used. For such cases a much more constraining rule (1/4, 1/5, 1/6 or even less) has to be applied. In the area of recreational cave diving CMAS does not advocate nor endorse any diving in caves with the current pointing inwards or changing in periodic intervals (e.g. tidal currents).
  - Latest after the first diver has reached his agreed "return pressure", the sign ABORT (thumb up) has to be immediately given and all members of the group have to turn and to exit from the cave in an orderly fashion.
- Stage Tank Depots:

If any of the stage tanks are deposited or taken up underway (entry and exit), the following rules must be observed:

  - Time for depositing/taking up the tanks has to be included in the dive plan.
  - The topic „stage tank handling activities“ has to be addressed during the briefing.
  - Location of depot must be selected very carefully (not in zones with silt and sediments, enough space for all handling activities, not in close vicinity of a restriction).
  - If cave topology allows, depth of depot location should NOT be below MOD of gas in these tanks.
  - If more than one depot is established, distance between them must be selected in a way that it can be covered with the content of the tank taken from the preceding depot.
  - Tanks must be deposited in a stable position (especially with current) and securely attached to the mainline and whenever possible, parallel or near parallel to the main axis of the passage and on both sides, in order to not create additional obstacles.
  - There must be no additional weight or other tensile forces on the mainline from the attached tanks (tanks **MUST NOT** hang "free" on the mainline).



## Standards & Training System

- The spacing between the tanks of the same depot should be approx. 2m (6-7 ft), so that divers are not disturbing each other during tank handling
- Tanks should be positioned so that tag with name of owner is pointing towards the approaching diver on the return way.
- Hoses should be left under pressure, but tank valve has to be closed (gives indication for leakages).
- 2nd stage must be carefully positioned on top of the tank (not on the floor or in the mud/silt) or otherwise protected from percolation, other debris and sediments.
- All tank handling activities (depositing/taking up) in the cave must be carried out in the most decent way in order to not stirring up silt and sediments and in a well planned and organized sequence within the team, especially in confined passages.
- After taking up the tank and having attached it to the harness, the diver must immediately open the tank valve and check the pressure.
- After visually checking the „gas tag“ on the 2nd stage and only if within the MOD of this gas, take a breath from it for checking (even if this tank is not to be used immediately), before continuing the return.
- An „everything OK?“ team check must be performed before proceeding any further (entry and exit).
- Underwater gas switch:
  - Reminder: valves of all tanks not actually in use must be closed.
  - A gas switch is a very crucial and safety related activity!
  - Take your time and stay where you are; do neither descend nor ascend during this procedure. Hustling may kill you.
  - Check owner's name and "gas tag" on tank (gas content); especially when you took this tank from a depot. If it's not YOUR tank, even if the content might be correct, don't breathe from it, except in a dead-or-alive emergency with no alternatives.
  - Check „gas-tag“ on regulator 2nd stage, if there is any. Indicated values must be congruent with the ones from the tag on the tank itself. If not, leave your fingers from this tank.
  - Check if you are within the indicated MOD.
  - BEFORE opening the valve of the picked up tank, it should be checked whether the correct 2nd stage has been taken or not by taking 2-3 breaths. Latest by then, the intermediate pressure hose should be empty, meaning that the correct tank and the correct regulator has been taken.
  - Select new gas on your computer; make sure that it is the same mixture as indicated on the tank.
  - Breathe cautiously for 20-30 seconds on site, be prepared to switch back to former gas in case *anything* strange happens.
  - Only if everything is still OK, then proceed further on.
- Air- and Oxygen decompression stops:
  - a) O<sub>2</sub>-decompression
    - Prerequisite for oxygen decompression is an Advanced Nitrox Certificate
    - Usage is accepted also during training courses (Cave Diver 2 and above)
    - Maximum operation depth: 6m/20ft
    - Quality: Oxygen 2.5
    - Only "true" O<sub>2</sub>-tanks are permitted; minimal size is 800 bar\*liters (4L x 200bar)
    - Each tank must be equipped with 100% O<sub>2</sub>-compatible regulator and submersible pressure gauge and must be deposited at the appropriate depth
    - It is recommendable to position the tank approx. 1m below the corresponding decompression stage, in order not to overshoot the ceiling (shallowest possible depth) during tank handling.
    - Divers who do not own a diving computer that allows for gas switches underwater must apply the decompression stop times for air or the used Nitrox mixture.
    - Air breaks follow standard operation procedures for O<sub>2</sub>-decompression.
    - For cases with overall air-decompression stop times of more than 20 min, the use of O<sub>2</sub>-decompression is *strongly recommended*.



## Standards & Training System

### Reason:

Explorations in and beyond zone 2 often result in very long decompression stop times with an increase risk of DCS. After appropriate training the cautious use of 100 % O<sub>2</sub> (with air-breaks) for the final stage decompression starting at 6m/20ft is the most efficient solution of the problem.

### b) other gases

- CMAS does not give any further recommendations or more restricting rules concerning the gases to be used for decompression, because the correct selection is totally dependent of the preceding dive profile and the gases used for it.
- In general terms, any breathable gas may be used that eliminates the accumulated tissue inert gas as quickly as possible by maintaining the oxygen window open to the maximum possible extent while observing all other physiological constraints and limits (such as pO<sub>2</sub>\_max, CNS, OTU).
- Commonly used mixtures are EAN80, EAN50.
- Attachment & securing small gear & regulators:
  - The second stage of any regulator in use has to be secured to the neck with a flexible rubber band or to a D-ring in the chest area in a way that it is ready for immediate use in an out-of-air situation.
  - Other small equipment parts and accessories such as emergency lights, cutters, compasses etc. are to be secured against dropping and losing by a safety lanyard.
  - Instruments have to be fixed as close as possible to the diver's body; no "danglies" are allowed
- Briefings / Debriefings:
  - It is compulsory that every cavern- or cave dive will be started with a thorough briefing by the responsible leader (guide, divemaster).
  - All team members have to attend the briefing.
  - The minimal content of a briefing is: site- and cave map presentation, specific characteristic of this cave (incl. dangers), group composition and buddy pair designation, agreed return point (turn pressure), intended tasks for each team member, required equipment, detailed dive plan (incl. gas switches), emergency plan, most important hand signals.
  - It is strongly recommended that every cavern/cave dive has to be terminated with a thorough debriefing.
  - If a debriefing is performed, all team members have to attend.
  - The minimal content of a debriefing is: discussion/evaluation of task-fulfilling, comments to specific situations and reactions, hints and advices for improved performance.
- Hand Signals:
  - A least all 4 command- plus the most important information- and request-hand signals (as described in chapter „Communication...“), their meaning and the expected correct reaction have to be rehearsed during a briefing. This is especially important if divers from different organizations come together with differences in communication.
  - The same holds true for the 5 touch-contact signals (move forward, everything OK, move backwards, stop, emergency).
  - If any team- or situation- or task-specific signals are to be used, it must be assured that every team-member has fully understood their meaning
- Material conditions and buddy checks:
  - At the beginning of every dive, all equipment and materials used has to be in good working condition.
  - Every diver is totally self-responsible for his own gear. This responsibility cannot be delegated.
  - At the beginning of every dive an equipment check among the buddy pairs has to be carried out (type: Head-to-Toe), and an additional safety check (leakage) on shallow depth (3-6m / 10-20ft). In case of any leakage, regardless how small it may be, the dive must be aborted and the cave must not be entered.
- Sump- and post-sump diving:
  - Post sump dives require a special planning (mainly with regard to emergency-planning) and an appropriate and detailed briefing



## Standards & Training System

- If necessary appropriate trekking material has to be carried with (ropes, carabines, ladders, additional lights, tackle bags)
- The gas quality (breathability) in a dry passage or a gas-filled cavity has to be checked cautiously; a basic rule is: unless breathability of the gas has been proven beyond any doubt, one should breathe only from the own regulator
- A thorough equipment check has to be carried out every time before diving into the next sump
- during any climbing activities everybody concerned has to be properly secured with safety lines/ropes
- It is compulsory to wear a helmet under CMAS safety regulations. Violation of this requirement will be regarded as gross negligence under all circumstances
- Because of the inherent danger of rising water (flooding) in otherwise dry passages the responsible leaders have the obligation to gather all relevant information well in advance from reliable and competent sources
- It is strongly recommended to carry boots with well profiled soles. The so-called „rock boots“ are a good choice. Use of boots with no profiles („slicks“) should be discouraged (it may even be dangerous)
- It must be made sure to have enough lighting equipment which is designed to be used outside the water
- Depending on the circumstances the use of special transportation means for the transport of heavy equipment and parts thereof should be foreseen.
- The weight of the equipment should be carefully reduced to the absolute minimum which is required by diving- and safety considerations
- Post-sump dives mostly are of longer duration and are physically demanding. It may be advisable to take some drinking water and even some food on the tour.
- During the crossing of dry passages, especially during transportation of equipment, special attention must be given to the cave environment in order to prevent any avoidable damage to it (breaking of stalactites, rubbish left behind, bat populations etc.)
- Solo diving:
  - In the area of recreational cave diving CMAS does not advocate nor endorse or support true solo cave diving (without backup).
  - The behavior of a non-professional recreational cave diver, performing a solo push-dive on his/her own in zone 2 or 3 without any team-backup, must be regarded as negligence or even as gross negligence.
  - For special conditions (tight squeezes, low visibility, depth etc.) it may be helpful and reasonable to carry out a temporary „one-man exploration“ from a certain point on. This is consistent with the understanding of autonomy that has developed over the years in the cave diving community. *Such procedures are then part of a well co-coordinated plan with a back-up group.*
  - In the area of professional working divers, no longer do these sport diver standards apply but other rules, mostly those of worker's unions or the applicable regulations of corresponding laws etc.
- **These iron rules may prevent your death:**
  - 1) **Never ever breath from a tank you have not filled or analyzed yourself and which is not marked with YOUR name**
  - 2) **Never ever breath in an „air-bell“ inside the cave from the contained gas if you have not a 100% proof that the gas is really breathable**
  - 3) **Never ever leave a main line without using a jump reel, secured to the main line**
  - 4) **Never ever swim over a gap or pass over a jump without connecting the two ends with your gap/jump reel**
  - 5) **Never adapt divers to the dive plan, but always adapt the plan to the cave and the divers**
  - 6) **Plan your dive – dive your plan**

### 8.6 Deviations from the general safety rules

Based on the accepted fact that not all caves are the same and that other important parameters may vary to a great extent from country to country, some national federations may - under given circum-



## Standards & Training System

stances - be allowed to apply rules deviating from above listed rules. Such deviations must be decided upon on the level of the corresponding national technical committee first and should be done (secondly) in agreement with the Cave Diving Working Group of CMAS International. However these modified rules must not be less safe than those outlined here.

If such changes are desired, the corresponding national federation has to file a written request to the CMAS Cave Diving Working Group der CMAS with detailed justification.

However the requested changes must not be put in effect before the Technical Committee of CMAS has fully accepted the positively formulated recommendation of the CMAS Cave Diving Group and this decision has been communicated in written form to the corresponding federation.

### 8.7 Summary (the ALL-rule)

The most important 3 rules in cave diving are summarized under the following terms (in German: the famous 3L-rule):

**Air (Luft) – Line (Leine) – Light (Licht)**

**General:** *Any incident, which makes it impossible to follow one of these rules and regardless for what reasons, has as a consequence the abortion of the dive and a return to the entry.*  
*In very rare and special cases it may be more advisable to try to escape to a gas-filled cavity (pocket) of adequate size with breathable air, which is in closest proximity and known by all team-members.*



## Part III: Standards for Cave Diver levels



## Standards & Training System

### 9. CMAS Cave Diver 1 / CD1 (Cavern Diver)

#### 9.1 Diver's profile / skills and competences

This is an advanced open water diver on cave diving entry level with the required knowledge and skills for using and applying the appropriate equipment and procedures to safely plan and execute dives in a **cavern** or in the **cavern zone (daylight zone, zone 1)** of a cave.



Two (2) up to a maximum of four (4) certified Cave Divers 1 are competent to dive *without* supervision or guidance of a cave diver of higher qualification level, if:

- a) the cavern or the cave has all the characteristics as defined for zone 1 (e.g. size of passages, guidelines etc.), otherwise diving is not permitted there.
- b) the dive site is familiar to them
- c) the actual circumstances at the dive site (e.g. visibility, current etc.) are identical or at least come close to those encountered during their training.

If only prerequisite **b)** is *not* fulfilled then it is mandatory that a certified cave diver with a higher qualification level (from Cave Diver 2 upwards) and who is *very familiar* with this specific dive site accompanies the group. The same applies for groups bigger than four divers.

If only **c)** is *not* fulfilled, then it is mandatory that a certified **cavern- or cave diving instructor** leads the group. Group size has to be limited to 4 cavern divers plus the instructor.

The diving perimeter is restricted to the cavern area in *any* case.

All dives have to be planned and executed in a way that any impairment of the flora and fauna of the cave is reduced to a bare minimum and the former state will be retained.

#### 9.2 Course prerequisites & requirements

##### 9.2.1 Requirements at start of course (admission)

- 2\* Diver CMAS or equivalent
- 25 logged open water dives
- 5 logged open water night dives
- valid medical attest for diving fitness according to the concerning requirements of the national federation (<= 1 year)
- ev. successfully passed entry assessment

##### 9.2.2 Requirements to be fulfilled until end of course

- minimum 16 years old

##### 9.2.3 Recommended specialty certificates

- \* UW-Orientation / Navigation
- \* Night Diver CMAS or equivalent

##### 9.2.4 Entry assessment (only if needed)

An entry assessment can be utilized to verify that candidates fulfill all prerequisites with regard to theoretical knowledge, practical skills and physical performance. Candidate must successfully pass all assessment requirements before being accepted to course.

#### 9.3 Minimum course duration

2.5 days

#### 9.4 Minimum course content

##### 2 classroom lectures (2-3 hrs / 0.5 days)

- introduction: what is recreational cave diving
- development and types of karst phenomena, caverns and caves
- protection and preservation of such caves



## Standards & Training System

- the CMAS Cave Diver's Etiquette (ref. to Appendix 5)
- risks and dangers of water-filled caverns and caves in general
- definition of zone 1
- cavern diver training
- special diving equipment for zone 1
- objective, function and correct handling of the required equipment for zone 1
- general safety rules and procedures for caverns and caves
- planning and preparation of cavern dives
- briefings and debriefings
- refresher in diving physics and physiology
- special diving techniques for zone 1
- emergency procedures

### 4 practical lessons (2 days)

- 4 training dives in at least 2 different caverns or entry zones of caves (zone 1) incl. assessment dives. Another suitable overhead environment can be used as a substitute (swimming caissons) if the main characteristics of a cavern are retained.
- training dives: refer to chapter 1.4 (Applications rules and procedures for use)

## 9.5 Academic reference & documentation

A nationally accepted manual such as „Cave Diving“ from CMAS.CH or an equivalent substitute

## 9.6 Course leadership / assistance

Cave Diving Instructor 1 CMAS in active teaching status. As assistants, Cave Diver 3 may be used, but not more than one (1) Cave Diver 3 per one (1) instructor.

## 9.7 Student : Instructor ratios

- in open water, confined area: max. 6 students per 1 instructor/assistant
- in zone 1 : max. 3 students per 1 instructor/assistant under normal (average) or above average conditions  
max. 2 students per 1 instructor/assistant under less than average conditions but still within the frame of zone 1 definitions

## 9.8 Evaluation

### a) theory

Theoretical knowledge will be evaluated with one single, written MC-test, consisting of 20 questions on the following topics: standards / planning / emergencies / karst & cave development / cave diving techniques / equipment / hand signals / physics / physiology.

In order to pass, the student must have a scoring of at least 80% (correct answers).

### b) practical skills

The *standard exercises/drills* for Cave Diver 1 have been added in Appendix 4a.

The skills evaluation is done within the framework of a continuous evaluation system. All required qualifications will be repeatedly assessed and evaluated during the training course. The certificate will only be given at a point when the candidate has finally passed all requirements.

## 9.9 Certification

- CMAS double-sided card
- wall certificate in A4 format

## 9.10 International comparison of certification level

This level corresponds to the classification Cavern Diver as defined by NACD, NSS, CDAA, PADI, NAUI, SSI, ANDI, TDI, IANTD and CDAA (incl. Sinkhole Class 1).

## 9.11 Activities and guiding/training competences

none



# CMAS Cave Diving

---



## Standards & Training System

### 10. CMAS Cave Diver 2 / CD2 (Cave Diver)

#### 10.1 Diver's profile / skills and competences

This is a more experienced cave diver with the knowledge on the correct usage of the required equipment and the skills to safely plan and organize cave dives in **zone 2** and to execute them in the company of other certified cave divers of same or higher level.



He masters all techniques to orient himself even under zero visibility and total loss of light or during a silt-out and is able to find safely back to the entrance.

The use of Nitrox mixtures up to 40 % is acceptable, provided that the required *Nitrox Diver* certification has been obtained beforehand.

All dives have to be planned and executed in a way that any impairment of the flora and fauna of the cave is reduced to a bare minimum and the former state will be retained.

#### 10.2 Course prerequisites & requirements

##### 10.2.1 Requirements at start of course (admission)

- 2\* Diver CMAS or equivalent
- 50 logged open water dives
- 10 logged open water night dives
- Cave Diver 1 CMAS (Cavern Diver) or equivalent or successfully passed assessment
- Nitrox Diver CMAS or equivalent (from 1.1.06 on)
- valid medical attest for diving fitness according to the concerning requirements of the national federation (<= 1 year)
- ev. successfully passed entry assessment

##### 10.2.2 Requirements to be fulfilled until end of course

- 4 cavern dives since Cave Diver 1 certification in zone 1 in at least 2 different caverns
- minimum 18 years old

##### 10.2.3 Recommended specialty certificates

- \* Gas Blender CMAS or equivalent
- \* Stage Tank Handling CMAS or equivalent
- \* Wreck Diver CMAS or equivalent
- \* Rescue Diver CMAS or equivalent

##### 10.2.4 Entry assessment (only if needed)

An entry assessment can be utilized to verify that candidates fulfill all prerequisites with regard to theoretical knowledge, practical skills and physical performance. Candidate must successfully pass all assessment requirements before being accepted to course.

#### 10.3 Minimum course duration

2.5 days

#### 10.4 Minimum course content

##### 3 classroom lectures (3-4 hours / 0.5 day)

- definitions of zones 2 and 3
- CMAS training standards and safety rules for the safe exploration of zones 2 and 3
- objective, function and correct handling of required special equipment for safe cave diving in zone 2 (incl. line work)
- special cave diving techniques in zones 1 and 2, incl. planning, organisation, preparation, briefing and debriefing
- special requirements of underwater orientation in caves
- causes, symptoms and effects for nitrogen narcosis and being out of breath
- causes, symptoms and effects of oxygen toxicity
- fundamentals of how to use Nitrox (with special focus on usage in caves)
- the governing parameters of decompression and the applied techniques with special focus on decompression with 100 % oxygen



## Standards & Training System

- calculation of gas consumption and of required gas supply, application of the rule of thirds, as well as additional deviating rules and the reasons for this
- analysis and assessment of a diving accident
- adequate 1st aid procedures and on-site care of a victim
- organisation of further support actions and alarming of rescue services
- cave mapping (cross-sections, distances, topology)
- the CMAS Cave Diver's Etiquette (ref. to Appendix 5)
- cave conservation and preservation

### 4 practical lessons (2 days)

- 4 dives in at least 2 different caves in zone 2
- training dives: refer to chapter 1.4 (Applications rules and procedures for use)

## 10.5 Academic reference & documentation

A nationally accepted manual such as „Cave Diving“ from CMAS.CH or an equivalent substitute

## 10.6 Course leadership / assistance

At least one (1) CMAS Cave Diving Instructor 2 in active teaching status. CMAS Cave Diving Instructors 1 can be used as assistants, but max. two (2) Cave Diving Instructors 1 per one (1) Cave Diving Instructor 2.

In reasonable cases Cave Diving Instructor 1 candidates can be used during their training. Such assistants must meet the following requirements: M\* / 20 years old / 300 dives / 30 cave dives / zone 2 + 20 cave dives / zone 3 / in min. 10 different caves.

## 10.7 Student : Instructor ratios

- in open water, confined area: max. 6 students per 1 instructor/assistant
- in zone 1 : max. 3 students per 1 instructor/assistant
- in zone 2 : max. 2 students per 1 instructor/assistant under normal (average) conditions  
or max. 3 students per 1 instructor/assistant under very good conditions with regard to visibility, current, percolation, temperature, simplicity of cave profile etc. AND when using air only as breathing medium (O<sub>2</sub>-decompression does not count for)

## 10.8 Evaluation

### a) theory

Theoretical knowledge will be evaluated with one single, written MC-test, consisting of 30 questions on the following topics: standards / planning & organisation / emergencies / karst phenomena and cave development / zones / cave diving techniques / uw-orientation / hand signals / equipment / gases / decompression.

In order to pass, the student must have a scoring of at least 80% (correct answers).

### b) practical skills

The *standard exercises/drills* for Cave Diver 2 have been added in Appendix 4b.

The skills evaluation is done within the framework of a continuous evaluation system. All required qualifications will be repeatedly assessed and evaluated during the training course. The certificate will only be given at a point when the candidate has finally passed all requirements.

## 10.9 Certification

- CMAS double-sided card
- wall certificate in A4 format

## 10.10 International comparison of certification level

This certification level corresponds with the (Apprentice) Cave Diver level from NACD, NSS, resp. CDAA Cave Diver (incl. Sinkhole Class 2).



## Standards & Training System

### 10.11 Activities and guiding/training competences

- may act as a divemaster (guidance) with already certified Cave Divers 1 in zone 1 under the terms outlined in chapter 6.1 (Cave Diver 1 / Diver's Profile, skills and competences).

# CMAS Cave Diving

---



## Standards & Training System

### 11. CMAS Cave Diver 3 / CD3 (Full Cave Diver)

#### 11.1 Diver's profile / skills and competences

This is very experienced open water *and* cave diver on the highest competence level with the knowledge and the skills for the correct use of all required materials and equipment in order to plan, prepare and organize cave dives in **zone 3** and to safely execute such dives in the company of other certified cave divers of the same level.



He has the competence to act as a divemaster and to guide other certified cave divers of equal or lesser level into their appropriate zones.

In the presence of a designated back-up team, he is able to carry out temporary single-diver explorations/penetrations.

He has the knowledge and the competence for mastering the specific techniques and procedures for planning and organizing tank deposits and usage of stage tanks, execution of long-distance penetration, mastering squeezes and post-sump diving, for the usage of Nitrox-mixtures and for O<sub>2</sub>-decompression.

The use of Nitrox mixtures higher than 40 % and of pure oxygen for decompression is acceptable, provided that the required *Advanced Nitrox Diver* certification has been obtained beforehand. This is strongly recommended anyway.

He masters all techniques to correctly lay a temporary or permanent cave line, to handling jumps, to repair gaps, to orient himself even under total loss of light or during a silt-out and to safely find back to the exit.

All dives have to be planned and executed in a way that any impairment of the flora and fauna of the cave is reduced to a bare minimum and the former state will be retained.

#### 11.2 Course prerequisites & requirements

##### 11.2.1 Requirements at start of course (admission)

- 3\* Diver CMAS or equivalent
- 100 logged open water dives
- 20 logged open water night dives
- CMAS Cave Diver 2 or equivalent or successfully passed assessment
- Rescue Diver CMAS or equivalent (if not included in the 3\* diver program!)
- Stage Tank Handling Specialty Course or Prep-Course to CD3 (from 1.1.06 on)
- Advanced Nitrox Diver CMAS or equivalent certificate of recognized organisation (from 1.1.06 on)
- valid medical attest for diving fitness according to the concerning requirements of the national federation (<= 1 year)
- ev. successfully passed entry assessment

##### 11.2.2 Requirements to be fulfilled until end of course

- 8 cave dives since Cave Diver 2 certification in zone 2 in at least 4 different caves
- minimum 18 years old

##### 11.2.3 Recommended Specialty Certificates

- \* all recommended specialties from Cave Diver 2 level
- \* valid 1<sup>st</sup> Aid and CPR certification from a nationally recognized organisation

##### 11.2.4 Entry assessment (only if needed)

An entry assessment can be utilized to verify that candidates fulfill all prerequisites with regard to theoretical knowledge, practical skills and physical performance. Candidate must successfully pass all assessment requirements before being accepted to course.

#### 11.3 Minimum course duration

5.5 days



## Standards & Training System

### 11.4 Minimum course content

#### 5 classroom lectures (5-6 hours/ 0.5 day)

- complete training standards & course scheme
- definitions of zones 1 to 3
- CMAS training standards and safety rules for the safe exploration of zones 2 and 3
- objective, function and correct handling of all required special equipment for safe cave diving in zone 3 (incl. line work)
- special cave diving techniques in zones 2 and 3, incl. detailed procedures for planning, organisation, preparation, briefing and debriefing
- special aspects of underwater orientation in caves
- specific techniques and procedures such as organizing tank deposits, requirements for long-distance penetration, usage of stage tanks, mastering squeezes and post-sump diving
- fundamentals for the usage of DPVs and rebreather for cave diving
- fundamentals of usage of Nitrox- and Trimix mixtures
- causes, symptoms and effects of nitrogen narcosis, oxygen toxicity and being short of breath
- the governing parameters of decompression and the applied techniques with special focus on decompression with 100 % oxygen
- calculation of gas consumption and of required gas supply, application of the rule of thirds, as well as additional deviating rules and the reasons for this
- execution of rescue activities in the cave and complete accident management
- analysis and assessment of a diving accident
- adequate 1st aid procedures and on-site care of a victim
- organisation of further support actions and alarming of rescue squad
- cave mapping (cross-sections, distances, topology)
- the CMAS Cave Diver's Etiquette (ref. to Appendix 5)
- cave conservation and preservation

#### 8 practical lessons (distributed over min. 5 days)

- min. 8 dives in 4 different caves in zone 3
- training dives: refer to chapter 1.4 (Applications rules and procedures for use)

### 11.5 Academic reference & documentation

A nationally accepted manual such as „Cave Diving“ from CMAS.CH or an equivalent substitute

### 11.6 Course leadership / assistance

At least two (2) CMAS Cave Diving Instructors 2 in active teaching status. In exceptional cases one (1) of these two (2) instructors may have a certificate of another recognized cave diving organisation (e.g. NACD, NSS). However, the responsible course director must always be a CMAS instructor.

CMAS Cave Diving Instructors 1 can be used as assistants, but max. two (2) Cave Diving Instructors 1 per one (1) Cave Diving Instructor 2.

### 11.7 Student : Instructor ratios

- in open water, confined area: max. 4 students per 1 instructor/assistant
- in zone 1 : max. 3 students per 1 instructor/assistant
- in zone 2 : max. 2 students per 1 instructor/assistant under normal (average) conditions  
max. 3 students per 1 instructor/assistant under very good conditions with regard to visibility, current, percolation, temperature, simplicity of cave profile etc. AND when using air only as breathing medium (O<sub>2</sub>-decompression does not count for)
- in zone 3 : max. 2 students per 1 instructor/assistant under normal conditions  
should be reduced to 1:1 if situation is considerably worse

### 11.8 Evaluation

#### a) theory

Theoretical knowledge will be evaluated with one single, written test, consisting of 40 questions (30 MC and 10 open, free text) on the following topics: course structures and -schemes / standards / plan-



## Standards & Training System

ning & organisation / emergencies / karst phenomena and cave development / underwater orientation / cave diving techniques / uw-orientation / hand signals / equipment / physics / physiology / decompression / gases / legal aspects.

In order to pass, the student must have a scoring of at least 80% (correct answers).

### b) practical skills

The *standard exercises/drills* for Cave Diver 3 have been added in Appendix 4c.

The skills evaluation is done within the framework of a continuous evaluation system. All required qualifications will be repeatedly assessed and evaluated during the training course. The certificate will only be given at a point when the candidate has finally passed all requirements.

## 11.9 Certification

- CMAS double-sided card
- wall certificate in A4 format

## 11.10 International Comparison

This certification level corresponds with the Full Cave Diver level (incl. stage diving) from NACD, NSS and Penetration from CDAA (incl. Sinkhole Class 3).

## 11.11 Activities and guiding/training competences

- may act as a divemaster (guidance) with already certified cave divers on level 1-3 in the appropriate zones.
- may act as an assistant during Cave Diver 1 (cavern courses) under direct supervision and control of a CMAS Cave Diving Instructor (any level) in active teaching status.  
**Attention:** for acting as an assistant during training, the diver in question must have a valid certification in \* 1<sup>st</sup> Aid and CPR from a nationally recognized organisation
- as a Cave Instructor 1 *Candidate*, he may also act as an assistant during Cave Diver 2 courses under direct supervision and control of a CMAS Cave Diving Instructor 2 in active teaching status.



## Standards & Training System

### 12. Overview on the governing parameters of the CMAS standards for Cave Diver levels 1 to 3

#### 12.1 Admission- and certification requirements

CMAS designation american equivalence	Cave Diver 1 (CD1) Cavern Diver	Cave Diver 2 (CD2) (Apprentice) Cave Diver	Cave Diver 3 (CD3) Full Cave Diver
age (years)	16	18	18
<b>prerequisite standard diving certificate</b>	2 star diver CMAS or equivalent	2 star diver CMAS or equivalent	3 star diver CMAS or equivalent
<i>recommended specialties</i>	Night Diving UW-Orientation/Navigation	Wreck Diving, Gas Blender, Stage Tanks, Rescue Diver	1st aid & CPR + all others from CD2
<i>compulsory cave diving specialties</i>	---	Nitrox Diver	Nitrox D., Rescue D., Stage Tanks
<b>prerequisite cave diving certificate</b>	---	Cave Diver 1 (CD1)	Cave Diver 2 (CD2)
min. number of OW-dives before	25	50	100
min. number of cave dives before	0	4 / zone 1 / 2 caverns since CD1	8 / zone 2 / 4 caves since CD2
min. course duration (days)	2.5	2.5	5.5
min. number classroom lectures	2	3	5
min. number practical lessons	4	4	8
min. number of training dives	4 / zone 1 / 2 caverns	4 / zone 2 / 2 caves	8 / zone 3 / 4 caves
Instructor:Students / free surface	1:6	1:6	1:4
Instructor:Students / overhead env.	1:3 (avrg. cond.) / 1:2 (< avrg.)	z1: 1:3 / z2: 1:2 (avrg. cond.) / 1:3 (> avrg.)	z1: 1:3 / z2: 1:2 (avrg.) & 1:3 (good/very good) / z3: 1:2 (max.)
permanent line in cave	yes	no	no
restrictions & squeezes	no (2 divers at same time)	no (2 divers at same time)	yes
traversing jumps/gaps	no	yes	yes
min. sight (m)	>= 10	>=3 and <10	0 to <3
max. depth (m)	20	30	40 (EAD)
max. penetration distance (m)	daylight zone entrance	up to 1/3 double tanks	up to 1/3 total supply
max. distance to surface (m)	50	unlimited	unlimited
type of gas for dive	air only	air / Nitrox *)	air / Nitrox, Trimix ****)
min. number / size of tanks	2000 bar*liter	3200 bar*liter %)	4000 bar*liter %)
stage tanks	no	no	yes
stage decompression allowed	no	yes	yes
type of gas for decompression	---	air / Nitrox / O2 **)	air / Nitrox / O2 **)
backup-mask	yes, 1 per group	yes, 1 per diver	yes, 1 per diver
intermediate pressure long-house (approx. 2m)	no	yes (1)	yes (1)
Safety Reel size (m) per diver	20 (zone 1)	20 (zone 2)	20 (zone 3)
Gap/Jump Reel size (m) per diver	no	Jump: 50 (zone 2)	Jump: 50 (zone 3)
Primary Reel size (m) per group	1 x 50 (zone 1)	1 x 100 (zone 2)	1 x 100 (zone 3)
min. number of independent lights	2 (zone 1)	3 (zone 2)	3 (zone 3)
solo-diving (totally alone)	no	no	no, only independent tasks
divemastering allowed / level +)	no	no	yes (up to CD3)
course assistance	no	no	yes; (CD1, cavern)
DPVs, Scooters	no	no	no, Specialty Course
Rebreather	no	no	no, Specialty Course
theory assessment / type	MC	MC	MC + FT ++)
number of questions	20	30	30 (MC) + 10 (FT)
minimal scoring	80%	80%	80%
+) under supervision Cave Diving Instructor (any grade)		*) Nitrox Diver Certificate	****) Trimix Diver Certificate
%) totally independent tanks or manifold with valve	++) MC=Multiple Choice / FT=free text	**) Advanced Nitrox Diver Certificate	DPV=diver propulsion vehicles

#### 12.2 Competences

certified as ----->	Cave Diver 1	Cave Diver 2	Cave Diver 3	Cave Diving Instructor 1 CANDIDATE
V course-/diver-level				
<i>Cave Diver 1</i>	<b>T (z1)</b>	<b>T (z1), G</b>	<b>T (z1), G, A</b>	<b>T (z1), G, A</b>
<i>Cave Diver 2</i>	---	<b>T (z2)</b>	<b>T (z2), G</b>	<b>T (z2), G, A</b>
<i>Cave Diver 3</i>	---	---	<b>T (z3), G</b>	<b>T (z3), G</b>
	<u>Legend:</u>			
	<b>G: Guide</b>		<b>T: Team-member, diver</b>	
	<b>A: Assistant</b>		<b>z1,2,3: zones 1,2,3</b>	
	<b>CANDIDATE: all prerequisites fulfilled, theory passed</b>			



### Part IV:

## Standards for Cave Diving Instructor levels





## Standards & Training System

### 13. CMAS Cave Diving Instructor 1 / CDI1 (Cavern Diving Instructor)

#### 13.1 Instructor's profile / skills and competences

This is a very proficient and experienced cave diver on cave instruction entry level who must have acquired beforehand the certifications as a CMAS Cave Diver 3 (Full Cave Diver) and as a 1\* Moniteur CMAS (or equivalent) . He has the required knowledge, the skills and the experience to teach in the classroom, in the swimming pool, in open water and in zone 1 of a cavern / cave and to organize and direct cave diving courses on level 1 in his own responsibility. He may also act as an assistant during Cave Diver 2 and 3 courses.



#### 13.2 Course prerequisites & requirements

##### 13.2.1 Requirements at start of course (admission)

- membership in the national federation for at least 1 year (must be in good standing!). For instructors having just passed a cross-over course to new federation, this requirement applies to the membership in the federation they are coming from.
- certification as CMAS Cave Diver 3 or equivalent (e.g. Full/Stage Cave Diver NACD/NSS or CDAA Penetration Diver, incl. Type 3 Sinkhole) for at least 1 year
- certification as 1\* Moniteur CMAS or equivalent in active teaching status
- a valid 1<sup>st</sup> Aid and CPR certification from a nationally recognized organisation
- valid medical attest for diving fitness according to the concerning requirements of the national federation (<= 1 year)
- guiding: 10 cave dives in zone 2 and 5 cave dives in zone 3 as a divemaster during guided tours (written confirmation by responsible CMAS Cave Diving Instructor 2 or 3)
- ev. successfully passed entry assessment

##### 13.2.2 Requirements to be fulfilled until end of course

- minimum 20 years old
- min. 300 open water dives in total
- min. 100 cavern- and cave dives in total, of which
  - \* min. 30 cave dives in zone 2 and
  - \* 20 cave dives in zone 3, of which min. 5 dives in the 40m depth range
  - \* in at least 10 different caves
  - \* written confirmation by a CMAS Cave Diving Instructor 2
- teaching/training experience:
  - \* assistance in 2 complete CMAS Cave Diver 1 courses (written confirmation by responsible CMAS course director / CMAS Cave Diving Instructor 1 to 3)

##### 13.2.3 Recommended Specialty Certificates

\* Advanced Nitrox Diver CMAS or equivalent

##### 13.2.4 Compulsory Specialty Certificates

- \* Rescue Diver CMAS or equivalent
- \* Nitrox Diver CMAS or equivalent

##### 13.2.5 Entry assessment (only if needed)

An entry assessment can be utilized to verify that candidates fulfill all prerequisites with regard to theoretical knowledge, practical skills and physical performance. Candidate must successfully pass all assessment requirements before being accepted to course.

#### 13.3 Minimum course content

- if not already covered by standard 1-star instructor course: the principles of teaching (methodology, teaching- & training aids etc.)
- standards and safety rules for cave diver level 1 and 2 and zones 1 and 2
- specific training techniques for the exploration in zones 1
- the required equipment and material for zones 1 and 2



## Standards & Training System

- all necessary diving techniques for zones 1 and 2
- the fundamentals of rescue and emergency management (techniques, organisation)
- legal aspects of instruction in general and in diver training

### 13.4 Evaluation

#### a) theory

Theoretical knowledge will be evaluated with one single test: a written theory test will be done in order to assure that theoretical knowledge meets the requirements outlined above. The test is a combination of 50 MC- questions about the following topics (number between brackets indicate recommended number of allotted questions to one topic):

- course organisation (7)
- teaching & training methodology (3)
- standards/ safety rules (5)
- emergencies (5)
- caves (4)
- cave diving techniques (5)
- cave diving equipment (5)
- physics (4)
- physiology (4)
- decompression/gases (4)
- legal aspects (4)

In order to pass, the candidate must have a scoring of at least 80% (correct answers).

#### b) practical cave diving skills

The skills evaluation is done within the framework of a continuous evaluation system. All required qualifications will be repeatedly assessed and evaluated during the training course. The certificate will only be given at a point when the candidate has finally passed all requirements.

Generally speaking, the Cave Diving Instructor 1 candidate must be able to *perfectly* demonstrate all drills and exercises on cave diver 1 and 2 level.

The evaluation has to be done by at least two (2) different CMAS Cave Diving Staff Instructors and with standardized evaluation forms.

#### c) classroom teaching

The candidate has to perform at least 2 evaluated classroom sessions during real cave diver courses on level 1 and 2 with real students with a grading of "C" (passed) or better.

The evaluation has to be done by at least two (2) different CMAS Cave Diving Staff Instructors and with standardized evaluation forms.

#### d) practical teaching

The candidate has to perform at least 2 evaluated practical sessions during real cave diver courses on level 1 and 2 with real students with a grading of "C" (passed) or better.

The evaluation has to be done by at least two (2) different CMAS Cave Diving Staff Instructors and with standardized evaluation forms.

#### e) general topics / overall competence level

Before being certified, the candidate must have shown proof of his ability to:

- to fully understand the complete CMAS cave diving training system with special emphasis on the cave diver level 1 and 2
- explain in detail all relevant rules for air-/gas-management and under which circumstances each specific rule should be applied
- explain the different requirements towards equipment and material beyond zone 1 and the reasons
- teach and demonstrate the complete theoretical and practical content of a Cave Diver 1 course, in the classroom, in the open (land, water), and in zone 1 itself
- safely lead, supervise and control a group of participants in zones 1 to 3
- teach/instruct a group of participants in zones 1 and 2
- communicate permanently and efficiently with a group under his control
- have the right attitude as a responsible CMAS Cave Diving Instructor



## Standards & Training System

### 13.5 Activities and guiding/training competences

- may act as a divemaster (guidance) with already certified cave divers and instructors of any level in the appropriate zones.
- planning, organisation and execution of complete CMAS Cave Diver 1 courses incl. classroom teaching, guiding, water work, examination and certification in his own responsibility. The chairman of the concerned commission in the national federation has the right to control the results of all evaluations at anytime.
- assistance during CMAS Cave Diver 2 courses and evaluation under direct supervision and control of min. one (1) CMAS Cave Diving Instructor 2 in active teaching status.
- assistance during CMAS Cave Diver 3 courses (except for evaluations) under direct supervision and control of min. two (2) CMAS Cave Diving Instructor 2 in active teaching status.

### 13.6 Training organisation

Training and certification will be planned and executed by a group of at least two (2) CMAS Cave Diving Staff Instructors in active teaching status, themselves appointed by the concerned commission of the national federation.

Well experienced Cave Diving Instructors 2 in active teaching status can be used as assistants.

### 13.7 Certification

- CMAS double-sided card
- wall certificate in A4 format

### 13.8 International comparison of certification level

With regard to the allotted competences, this certification level corresponds with the level Cavern Diving Instructor as defined by organisations such as NACD, NSS and CDAA.

# CMAS Cave Diving



## Standards & Training System

### 14. CMAS Cave Diving Instructor 2 / CDI2 (Full Cave Diving Instructor)

#### 14.1 Instructor's profile / skills and competences

This is an advanced and experienced cave diving instructor who must have acquired beforehand the certifications as a CMAS Cave Diving Instructor 1 (Cavern Diving Instructor) and as a 2\* Moniteur CMAS (or equivalent) .



He has the required knowledge, the skills and the experience to teach in the classroom, in the swimming pool, in open water and in zones 1 to 3 on all cave diving levels and to organize and direct Cave Diver 1 and 2 courses in his own responsibility and Cave Diver 3 courses together with another Full Cave Diving Instructor in active teaching status.

#### 14.2 Course prerequisites & requirements

##### 14.2.1 Requirements at start of course (admission)

- membership in the national federation for at least 2 years (must be in good standing!). For instructors having just passed a cross-over course to new federation, this requirement applies to the membership in the federation they are coming from.
- certification as 2\* Moniteur CMAS or equivalent in active teaching status
- certification as CMAS Cave Diving Instructor 1 or equivalent for at least 1 year in active teaching status
- a valid 1<sup>st</sup> Aid and CPR certification from a nationally recognized organisation
- valid medical attest for diving fitness according to the concerning requirements of the national federation (<= 1 year)
- guiding: 5 cave dives in zone 2 and 10 cave dives in zone 3 as a divemaster during guided tours (written confirmation by responsible CMAS Cave Diving Instructor 2 or 3) since certification as CMAS Cave Diving Instructor 1

##### 14.2.2 Requirements to be fulfilled until end of course

- min. 25 years old
- min. 600 open water dives in total
- min. 150 cavern- and cave dives in total
  - \* of which min. 75 in z2+z3,
  - \* in min. 15 different caves
- min. 20 cave dives in zone 3 since certification as CMAS Cave Diving Instructor 1, of which min. 5 dives in the 40m depth range (written confirmation by another CMAS Cave Diving Instructor 2 or 3)
- teaching/training experience:
  - \* organisation and execution of at least 2 complete CMAS Cave Diver 1 courses
  - \* assistance in 2 complete CMAS Cave Diver 2 courses
  - \* assistance in 1 complete CMAS Cave Diver 3 course(written confirmation by the concerned responsible CMAS Cave Diving Instructor 2 or 3)
- ev. successfully passed entry assessment

##### 14.2.3 Recommended Specialty Certificates

\* Advanced Nitrox Diver CMAS or equivalent

##### 14.2.4 Compulsory Specialty Certificates

- \* Rescue Diver CMAS or equivalent
- \* valid 1<sup>st</sup> Aid and CPR certification from a nationally recognized organisation
- \* Nitrox Diver CMAS or equivalent

##### 14.2.5 Entry assessment (only if needed)

An entry assessment can be utilized to verify that candidates fulfill all prerequisites with regard to theoretical knowledge, practical skills and physical performance. Candidate must successfully pass all assessment requirements before being accepted to course.



## Standards & Training System

### 14.3 Minimum course content

- the principles of cave diving training in general, with specific focus on CMAS Cave Diving Instructor 1 level
- teaching methodology for exploration of zones 1 to 3
- all required equipment and material for zones 1 to 3
- all necessary diving techniques for zone 3
- the fundamentals of rescue and emergency management (techniques, organisation)
- legal aspects of instruction in general and in diver training

### 14.4 Evaluation

#### a) theory

Theoretical knowledge will be evaluated with one single test: a written theory test will be done in order to assure that theoretical knowledge meets the requirements outlined above. The test is a combination of 40 MC- and 10 open (free-text) questions about the following topics (number between brackets indicate recommended number of allotted questions to one topic):

- course organisation and training schemes (8)
- teaching- and training methodology (5)
- standards/ safety rules (5)
- emergencies (4)
- caves (4)
- cave diving techniques (5)
- cave diving equipment (8)
- physics (2)
- physiology (2)
- decompression theory/gases (3)
- legal aspects (4)

In order to pass, the candidate must have a scoring of at least 80% (correct answers).

#### b) practical cave diving skills

The skills evaluation is done within the framework of a continuous evaluation system. All required qualifications will be repeatedly assessed and evaluated during the training course. The certificate will only be given at a point when the candidate has finally passed all requirements.

Generally speaking, the Cave Diving Instructor 2 candidate must be able to *perfectly* demonstrate all drills and exercises on cave diver 1 to 3 level.

The evaluation has to be done by at least two (2) different Cave Diving Staff Instructors and with standardized evaluation forms.

#### c) classroom teaching

The candidate has to perform at least 2 evaluated classroom sessions during real cave diver courses on level 2 and 3 with real students with a grading of "C" (passed) or better.

The evaluation has to be done by at least two (2) different Cave Diving Staff Instructors and with standardized evaluation forms.

#### d) practical teaching

The candidate has to perform at least 2 evaluated practical sessions during real cave diver courses on level 2 and 3 with real students with a grading of "C" (passed) or better.

The evaluation has to be done by at least two (2) different Cave Diving Staff Instructors and with standardized evaluation forms.

#### e) general topics / overall competence level

Before being certified, the candidate must have shown proof of his ability to:

- have a profound knowledge of the complete CMAS cave diving training system with special emphasis on the cave diver level 1 to 3
- explain in detail all relevant rules for air-/gas-management and under which circumstances each specific rule should be applied
- explain the different requirements towards equipment and material of each zone and the reasons behind with special emphasis on zone 3



## Standards & Training System

- safely lead, supervise and control a group of participants in zones 1 to 3
- teach/instruct a group of participants in zones 1 to 3
- teach the complete theoretical and practical content of cave diver level 1 to 3 courses, in the classroom, in the open (land and water) and in the zones 1 to 3
- communicate permanently and efficiently with a group under his control
- have the right attitude as a responsible CMAS Cave Diving Instructor
- cooperate and give support within the training of new CMAS Cave Diving Instructors 1

### 14.5 Activities and guiding/training competences

- may act as a divemaster (guidance) with already certified cave divers and instructors of any level in the appropriate zones.
- planning, organisation and execution of complete CMAS Cave Diver 1 and 2 courses incl. classroom teaching, guiding, water work, examination and certification in his own responsibility. The chairman of the concerned commission in the national federation has the right to control the results of all evaluations at anytime.
- min. two (2) CMAS Cave Diving Instructors 2 (OR one (1) Cave Diving Instructor 2 and one (1) Cave Diving Staff Instructor), both in active teaching status and after notification of the responsible commission in the national federation, are empowered to jointly plan, organize and execute complete CMAS Cave Diver 3 courses incl. classroom teaching, water work, examination and certification. The chairman of this commission has the right to control the results of all evaluations at anytime.
- assistance during CMAS Cave Diving Instructor 1 courses and evaluation under direct supervision and control of min. two (2) CMAS Cave Diving Staff Instructors in active teaching status.
- designated (officially nominated) Staff Instructor *Candidates* may be used as assistants during Cave Diving Instructor 2 training courses (except for evaluations).

### 14.6 Training organisation

Training and certification will be planned and executed by a group of at least two (2) CMAS Cave Diving Staff Instructors in active teaching status, after permission is granted by the corresponding commission of the national federation.

### 14.7 Certification

- CMAS double-sided card
- wall certificate in A4 format

### 14.8 International comparison of certification level

This certification level corresponds to the level of a full cave diving instructor in organisations such as NACD, NSS, and CDAA. However in the CMAS system a full cave diving instructor has not the competence to act as a course director in Cave Diver 3 courses on its own.



## Standards & Training System

### 15. CMAS Cave Diving Instructor 3 / CDI3 (CMAS Cave Diving Staff Instructor)

#### 15.1 Instructor's profile / skills and competences

This is a most proficient and experienced cave diving instructor on highest competence level, who must have been certified beforehand as CMAS Cave Diving Instructor 2 and 2\* Moniteur (or equivalent) and who can show proof of all required activities.

The candidate has all required knowledge, skills, and experience to develop, organize, execute, direct, coordinate and control the training of cave divers and of cave diving instructors on all levels, nationally and internationally. He is the teacher of the cave diving instructor staff of the national federation (in French: le formateur des formateurs).



Normally candidates for the staff instructor level are nominated from the rows of Cave Diving Instructors 2 with a long-term and proven training and working experience on all levels of cave diving on a national and international level.

He must be most proficient in adapting existing present training schemes to new demands from the field, in developing new training structures and schemes, in working in different commissions on national and international level and in establishing and maintaining contacts to other federations or in negotiations with such organisations.

***Training (if any) and nomination is performed by the corresponding commission of the national federation.***

#### 15.2 Prerequisites for a potential nomination

##### 15.2.1 Requirements for nomination as a *candidate* (admission)

- membership in the national federation for at least 5 years (must be in good standing!). There are NO cross-over courses at that level !
- min. 30 years old
- certification as 2\* Moniteur CMAS or equivalent for at least 2 years in active teaching status
- certification as CMAS Cave Diving Instructor 2 for at least 2 years in active teaching status
- min. 1000 open water dives in total
- min. 200 cave dives in total, of which min. 100 in z2+z3, in min. 20 different caves
- min. 20 cave dives in zone 3 since certification as CMAS Cave Diving Instructor 2, of which min. 5 dives in the 40m depth range (written confirmation by another CMAS Cave Diving Instructor 2 or 3)
- valid 1<sup>st</sup> Aid and CPR certification from a nationally recognized organisation
- valid medical attest for diving fitness according to the concerning requirements of the national federation (<= 1 year)
- teaching/training experience:
  - \* min. 3 years of proven training experience on CMAS Cave Diver level 1 to 3.
  - \* support as a course assistant and as an expert during at least 2 CMAS Cave Diving Instructor 1 courses under supervision and control of a CMAS Cave Diving Staff Instructors.
- he must be familiar with the structures and cave diving training schemes of other federations on international level

##### 15.2.2 Requirements to be fulfilled during activities in candidate status

- support as a course assistant and as an expert during at least two (2) complete CMAS Cave Diving Instructor 2 courses under supervision and control of two (2) CMAS Cave Diving Staff Instructors.
- if required: successful execution of a assigned project, complete study/master thesis

##### 15.2.3 Recommended Specialty Certificates

- \* Advanced Nitrox Diver CMAS or equivalent



## Standards & Training System

### 15.2.4 Compulsory Specialty Certificates

- \* Rescue Diver CMAS or equivalent
- \* Nitrox Diver CMAS or equivalent

### 15.3 Promotion

***Nomination and promotion will be performed by the corresponding commission of the national federation.***

***There is no granted right for nomination and promotion, this will be done on the grounds of the real needs and is in the sole competence of the corresponding commission of the national federation.***

### 15.4 Minimum course content

There is no defined „staff instructor course“.

The guidelines for nomination however, are defined by the Cave Diving Working Group of CMAS and executed on operational level by the corresponding national commission.

### 15.5 Evaluation

#### a) theory and b) practical skills

Basically, there is neither a written test nor a practical skills evaluation anymore. The candidate must show proof of his overall competence by his work and the results out of it within the federation and/or on an international level.

***CMAS strongly recommends to give the applicants a specific task in the form of a cave diving related project, whose results are presented in the form of a new training course, a study or master thesis. Evaluation of results has to be done by the appropriate commission of the national federation.***

#### c) classroom teaching and d) practical teaching

Generally, the same holds true as outlined under a) and b). The candidate must show proof of his overall competence by his work and the results out of it within the federation and/or on international level.

#### e) general topics / overall competence level

The candidate must be able to organize and direct the complete theoretical and practical training of Cave Diving Instructors 1 and 2, incl. assessment and evaluation, from the planning to the certification. He must also be able AND willing to work on a national and international level.

### 15.6 Activities and guiding/training competences

- may act as a divemaster (guidance) with already certified cave divers and instructors of any level in the appropriate zones.
- organisation and execution of cave diver courses up to level 2 in his own responsibility and competence. The chairman of the concerned commission in the national federation has the right to control the results of all evaluations at anytime.
- one (1) CMAS Cave Diving Staff Instructor, together with at least one (1) CMAS Cave Diving Instructor 2, both in active teaching status and after notification of the responsible commission of the national federation, are empowered to jointly plan, organize and execute complete CMAS Cave Diver 3 courses incl. classroom teaching, water work, examination and certification. The chairman of this commission has the right to control the results of all evaluations at anytime.
- min. two (2) CMAS Cave Diving Staff Instructors in active teaching status are empowered to jointly plan, organize and execute complete CMAS Cave Diving Instructor courses up to level 2, incl. examination and certification, after permission is granted by the corresponding commission of the national federation. The chairman of this commission has the right to control the results of all evaluations at anytime.
- designated (officially nominated) Staff Instructor *Candidates* may be used as assistants during Cave Diving Instructor 2 training courses
- project-leadership and/or assistance during development of new teaching and training standards, guidelines and safety rules for cave diving on national and international level.





## **Standards & Training System**

### **15.7 Training organisation**

There is no defined specific training.

Promotion/certification will be executed on national level by the corresponding commission of the national federation.

### **15.8 Certification**

- CMAS double-sided card
- wall certificate in A4 format

### **15.9 International comparison of certification level**

This certification level corresponds to the level of a course director / instructor trainer in organisations such as NACD, NSS, and CDAA.

# CMAS Cave Diving



## Standards & Training System

### 16. Overview on the governing parameters of the CMAS standards for Cave Diving Instructor levels 1 to 3

#### 16.1 Admission- and certifications requirements

CMAS level designation	Cave Diving Instructor 1 (CDI1)	Cave Diving Instructor 2 (CDI2)	Cave Diving Instructor 3 (CDI3)
age (years)	20	25	30
membership federation / duration (Cross-over instructors: applies to former federation)	min. 1 year	min. 2 years	min. 5 years
possibility for cross-over course	yes	yes	no
medical attest on fitness for diving	yes, <= 1 year	yes, <= 1 year	yes, <= 1 year
active teaching status	yes, as OW-Instructor	yes, as Cave Diving Instructor 1	yes, as Cave Diving Instructor 2
standard-ow-instructor certificate / duration	M* CMAS or equivalent	M** CMAS or equivalent	M** CMAS or equivalent / min. 2 years
recommended specialty certificates	Advanced Nitrox Diver	Advanced Nitrox Diver	Advanced Nitrox Diver
compulsory specialty certificates	Rescue Diver or equivalent 1st aid & CPR Nitrox Diver	<----- (same as CDI1)	<----- (same as CDI2)
preceeding cave diving certificate/duration	CD3 for min. 1 year	CDI1 for min. 1 year	CDI2 for min. 2 years
min. number of dives (in total)	300	600	1000
min. number of cave dives	100	150	200
of which min. in zone 1	no specif. req.	no specif. req.	no specif. req.
of which min. in zone 2	30	75 in total, of which	100 in total, of which
of which min. in zone 3	20, 5 in 40+m range	20 since CDI2, 5 in 40+m range	20 since CDI2, 5 in 40+m range
min. number of different caves	10	15	20
guiding/divemastering in zone 1	10 (in total)	5 since CDI1	no specif. req.
guiding/divemastering in zone 2			
guiding/divemastering in zone 3			
assistance in CD1 courses	2	no specif. req.	no specif. req.
self-organized CD1 courses/leadership	---	2	
assistance in CD2 courses	---	2	1 since CDI2
self-organized CD2 courses/leadership	---	---	
assistance in CD3 courses	---	1	2 since CDI2
self-organized CD3 courses/co-leadership	---	---	
assistance/co-leadership CD1 courses	---	---	2
assistance/co-leadership CD12 courses	---	---	2 (as Staff Instr. Candidate)
min. duration ITC (days)	8 (within real CD1/2 course)	8 (within real CD2/3 course)	no course
number of evaluated classroom lectures	2	2	Assessment of all activities (3 years permanently on levels CD1-3)
number of evaluated practical lessons	2	2	
theory assessment / type	MC	MC + FT *)	no test
number of questions	50	40 (MC) + 10 (FT)	project work, study; Master Thesis
minimal scoring	80%	80%	

\*) MC = Multiple Choice; FT = free text, open questions

#### 16.2 Competences

certified as ----->	Cave Diving Instructor 1	Cave Diving Instructor 2	Cave Diving Instructor 3 CANDIDATE	Cave Diving Instructor 3
V course level				
Cave Diver 1	G, A, E, C(1)	G, A, E, C(1)	<-----	<-----
Cave Diver 2	G, A, E	G, A, E, C(1)	<-----	<-----
Cave Diver 3	G, A	G, A, E, C(2)	<-----	G, A, E, C (with 1 CDI2)
Cave Diving Instructor 1	G	G, A, E	<-----	G, A, E, C(2)
Cave Diving Instructor 2	G	G	G, A	G, A, E, C(2)
Cave Diving Instructor 3	No Course / Nomination and promotion by nat. commission			
Legend:				
G: Guide		C: respons. Course director		
A: Assistant		(n): min. number of instructors		
E: Evaluator		CANDIDATE: nominated by nat. commission		



## Standards & Training System

### 17. Cross-overs and Exception Handling

#### 17.1 Cross-over courses for cave diving instructors of other recognized organisations

For cave diving instructors from other recognized organisations (e.g. NACD, NSS, CDAA), who wish to teach for CMAS, there is the possibility to follow a cross-over course.

The detailed procedures for such a course are outlined in a separate document (refer to "**Cave Diving - Rules and procedures for Instructor Cross-over**"). You may get more information from the CMAS Cave Diving Working Group.

Generally speaking, the cross-over candidate must prove to fulfill all requirements of the intended level as defined by CMAS-standards outlined here.

**Note: CMAS does NOT allow for cross-over courses at Cave Diving Instructor 3 level.**

#### 17.2 Exception handling

It can be assumed that there are nationally or internationally known cave divers of outstanding reputation who would like to support or to be involved in the formal training of other cave divers or may be just interested to acquire a cave diver's certificate. It may also be assumed that the national federation itself is interested to get a benefit from the knowledge and the skills of such an expert. In both cases, sticking exactly to the letter of the standards and detailed procedures may be counterproductive and against common sense.

In such well defined exceptional cases it is within the competence of the concerned national commission to grant an individual deviation from the standard rules.

**On instructor level the candidate has always to present a proof of his ability to teach from a recognized training organisation (e.g. teacher's license, moniteur certificate etc.)**

#### 17.3 Detailed course-outlines and examination procedures

Detailed documentation for the preparation and procedures for all cave diving training courses may be obtained from the appropriate commission and its board within the national federation.



## Standards & Training System

### 18. Maintaining active teaching status for CMAS Cave Diving Instructors

#### 18.1 General

Each federation has a vital interest that instructors and training staff permanently maintain their knowledge and skills on the top-most actual level. This requirement is even more important in safety-related areas.

It's for this reason that only cave diving instructors in active teaching status are allowed to train and certify students, regardless of the level.

The federation's administration or the concerned commission will notify cave diving instructor not fulfilling the requirements and will switch their status from "active"/"teaching" to "inactive"/"non-teaching".

#### 18.2 Restrictions/Constraints

- 1) The following requirements are valid for ALL cave diving instructor levels.
- 2) Other diving and training activities outside of cave diving do NOT account for maintaining an active teaching status as a cave diving instructor.

In contrast to this, training activities within cave diving DO account for maintaining active teaching status as an open water instructor of the same national federation.

#### 18.3 Evaluation period

One evaluation period always covers two (2) years. In this period, the year of having received the instructor certificate is included.

#### 18.4 Requirements

The requirements take into account (pt. 2 below) that there may be CMAS cave diving instructors in one national federation, which at the same time, are NOT open water instructors within the same national federation.

To keep active teaching status, the instructor has to show proof of the following:

1. valid membership in the respective national federation (as an "ordinary" member, not as an instructor)
2. active teaching instructor status in the national federation or in another dive training organisation which is recognized by the own national federation.
3. valid medical attest (fit for diving)
4. proof of at least 20 cave dives (privately done or during courses) during the evaluation period
5. organisation/course leadership/assistance of (or during) at least one (1) cave diving course. As a substitute, the participation at a complete cave diving instructor training course OR instructor refresher OR the active participation in a cave diving or cave research related project on national or international level is also accepted.

In specific cases, other cave diving or at least diving-related activities may also be accepted. For such cases, the chairman of the national commission concerned has to be contacted beforehand.

#### 18.5. Regaining active teaching status

Inactive cave diving instructors (non-teaching status) wishing to regain active teaching status may contact the responsible chairman of the appropriate commission within the national federation.

As soon as the required activities have been proved and controlled, the instructor concerned will be notified by the federation's administration of his regained teaching status with all associated duties and privileges.



## Part V: Appendices

# CMAS Cave Diving



## Standards & Training System

### Appendix 1a: Designations of CMAS cave diving certificates and levels

	CMAS level designation (english)	<b>Cave Diver 1</b>	<b>Cave Diver 2</b>	<b>Cave Diver 3</b>
	CMAS titres des brevets (français)	<b>plongeur spéléo 1 / plongeur en cavernes</b>	<b>plongeur spéléo 2 / plongeur spéléo (de base)</b>	<b>plongeur spéléo 3 / plongeur spéléo avancé</b>
	american equivalence	<i>Cavern Diver</i>	<i>(Apprentice) Cave Diver</i>	<i>Full Cave Diver</i>
	british equivalence (CDG UK)	-----	<i>orientation towards cave diving</i>	<i>qualified cave diver</i>
	australian equivalence	Cavern Diver (incl. Sinkhole 1)	Cave Diver (incl. Sinkhole 2)	Full Cave Diver (Penetration+Sinkhole 3)
	deutsch	<i>Höhlerntaucher 1 / HT1</i>	<i>Höhlerntaucher 2 / HT2</i>	<i>Höhlerntaucher 3 / HT3</i>
	español	buceador de cavernas	buceador de cuevas	buceador de cuevas avanzado
	italiano	speleosub in caverne	speleosub in grotte	speleosub in grotte avanzato

### Appendix 1b: Comparison of different international cave diver certification systems

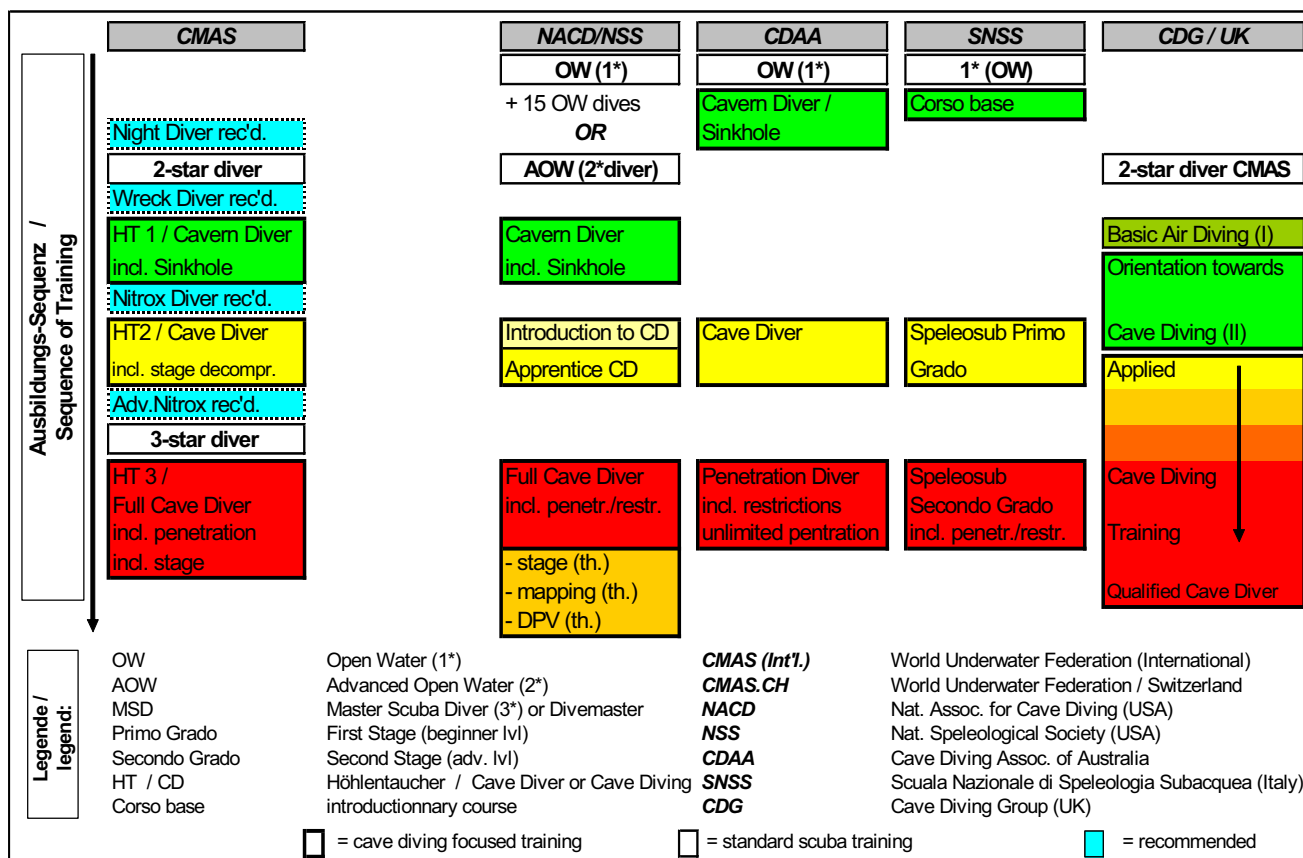



## Standards & Training System

### Appendix 2: Underwater Communication in Cave Diving

#### A2.1 Cave Diving Hand Signals

Hand signals are one of the most efficient ways of underwater communication to quickly transfer detailed information. Thus, CMAS has defined and published already long time ago a complete set of worldwide accepted underwater hand signals.

In cave diving, **basically the same hand signals are used as for open water diving (those remain unchanged !)** plus a considerable collection of specific cave- and cave diving related additional signals. This is the reason that in the following paragraph the main focus is on those specific hand signals for cave diving.

In view of the difficult conditions in cave diving and the probability of a catastrophic outcome after misunderstandings, it is unforgivable if the cave diver does not perfectly master hand signals.

##### A2.1.1 Command signals

There are four command signals. They are called this way, because there is only one correct and acceptable response and reaction. They have one point in common: they are NEVER to be questioned!

Those four signals are:

1. OK
2. STOP
3. RETURN (without abort)
4. SURFACE (ascent to) / ABORT DIVE !

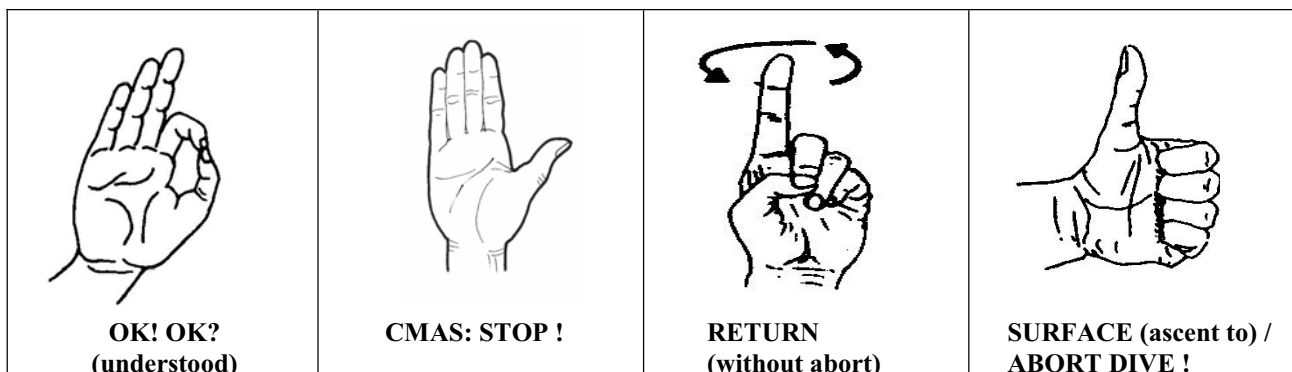

#### Remarks:

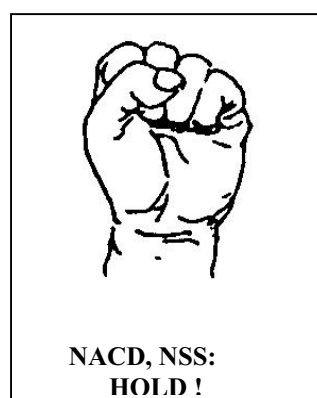

**STOP (CMAS) / HOLD (NACD):** In areas where American cave diving organisations such as NACD and NSS/CDS are strongly represented, the signal HOLD (at the left) is used instead of the CMAS STOP command (s. above).

**Attention** in order NOT to confuse the HOLD command (fist) with the CMAS signal "I have reached my reserve" (fist besides your head). From a legal standpoint it is obvious that in countries with the CMAS system and an official national federation, the existing CMAS STOP command must be used first.

Both signals have the same meaning: it means "stop", "wait" "go no further". Once given no diver may continue the dive, until cleared to do so by an OK or a RETURN.

An initial HOLD can mean that the diver giving the signal needs to stop briefly or he doesn't want to penetrate any further or that he wants to exchange more information (followed by additional hand signals).

**SURFACE (ascent do) / ABORT DIVE !** Because SURFACE is a command signal it must NEVER be questioned by anyone from the team. The only acceptable answer is the SURFACE signal from every diver from the team. In further correct response, all divers ascent to the surface - if there is any - or exit from the cave in an orderly fashion.

In cave diving, SURFACE at the same time also means ABORT THE DIVE!

# CMAS Cave Diving



## Standards & Training System

### A2.1.2 Information signals



little, squeeze



ceiling



sediments, silt



depth reached  
(maintain)



line (+action)



big, many

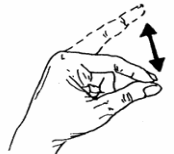

bubbles  
(e.g. during check)

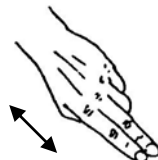

knife (+action)



back-up light is on!

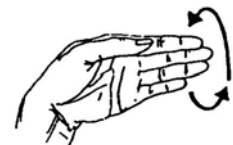

reel  
(+action)



(I'm) stuck



Exit (this way)



entanglement



### A2.1.3 Requests for actions/activities



attach/fix line  
(Tie-Off)



slow down / slow



cut (line)

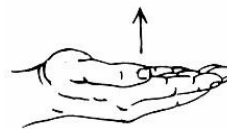

higher up/upwards  
(ascent a little bit)

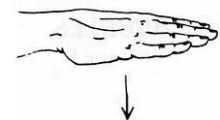

down/downwards  
(sink a little bit)

### A2.1.4 Numbers



0



1



2



3



4



5



6



7



8



9

### A2.2 Application of hand signals

Hand signals must be given clearly, distinctively and convincingly. If there is not enough natural light at the site, try to illuminate your hand adequately so it can be better seen. Another way is to point the lamp towards the





## Standards & Training System

own body and make the signals within the cone of light. However, it is still the best method to have your buddy within an arm's reach, so it is possible to establish immediate physical (touch) contact.

### A2.3 Touch-contact signals

In cases where it is advisable to dive with touch-contact (e.g. during a silt-out, an out-of-air situation), meaning that a direct eye-to-eye contact is not possible and both divers had to use one of their hands for negotiating this emergency, a minimum communication must be maintained with all means.

During this procedure one of the divers holds his buddy with a firm grip of his hand on the upper arm or leg. The following signals can be communicated:

One Squeeze	▶	Hold, STOP
Two Squeezes	▶	everything OK!
Forward Push	▶	Move forward
Backward Pull	▶	Move backward
Four Squeezes	▶	Emergency situation, stuck or out-of-air situation

### A2.4 Line/rope signals

Even in these days, during exploration of new passages, restrictions, short one-man explorations, all these activities under low to zero visibility conditions, a direct connection between a tender and the diver is still in use as a quick and cheap method to realize. This safety line is then also used for communication.

It is self-understanding that this technique can only be used for relatively short and preferably straight passages, because (e.g.) of the danger of line entanglement. It is also essential to reduce line slack to a minimum because otherwise line signals will be hard to understand.

While using line/rope signals the sender always announces his intention to the addressee with a pre-signal, given by a short pull. The addressee acknowledges by sending the same signal back. Only then the intended message is being transmitted. This procedure is almost identical to the one used in wireless communication.

The following, most common signals correspond to those used by the US-Navy:

ONE short pull	▶	Tender: everything OK? A signal/message is to come! During diver's descent: STOP! Diver: everything OK; I await signal! Although: I have reached the bottom.
TWO long pulls	▶	Tender: advance further/descend During diver's ascent: you have ascent too much; descend until being stopped Diver: I need more line
THREE long pulls	▶	Tender: prepare to return/ascent Diver: take up slack (of line)
FOUR long pulls	▶	Tender: Emergency, return/ascent immediately Diver: Emergency, pull me back/to the surface



## Standards & Training System

### Appendix 3: Guidelines for gases, rebreathers, stage tanks and DPVs during CMAS standard cave diving courses

#### General

The rapid development in the area of sport diving in relation to the usage of special gas mixtures and rebreather didn't stop in cave diving.

However, for legal and technical reasons it is compulsory to control and regulate the use of such technology during the standard training courses within reasonable limits.

The following rules and regulations are compulsory for all participants of CMAS cave diving seminars and courses and are an integrated part of the subscription. Violation of those rules by the participants will lead to expulsion without compensation.

#### Usage of stage tanks (all types)

- from a penetration distance of 500m or more without the possibility to re-surface, a 3<sup>rd</sup> tank has to be carried with (stage tank, 3 tank rig) or to be deposited on a suitable place.
- minimum size for this tank is 7 liters. The rule of thirds (or a more restrictive one) has also to be applied to this tank.
- all tanks must be equipped with one complete regulator rig (incl. pressure gauge).
- all tanks that may be deposited somewhere in the cave during the dive have to be clearly marked with the name of the owner.
- in addition to this, it is recommended to write the MOD in big sized numbers (approx. 10cm / 4 in.) directly on the tank

#### Usage of Nitrox

- not *necessarily* to be used during Cave Diver 1 and 2 courses; may be used during Cave Diver 3 courses
- prerequisite is Nitrox-Diver Certificate
- Nitrox-compatible dive computer required
- for MOD: max. pO<sub>2</sub> as set forth by law, in the regulations of the national federation or by CMAS International.
- no dive with a tank whose content has not been personally analyzed !

#### Stage decompression with 100% oxygen

- prerequisite is Advanced Nitrox Certificate or medical recommendation
- usage is accepted also during training courses (Cave Diver 2 and above)
- maximum operation depth: 6m/20ft
- quality: Oxygen 2.5
- only "true" O<sub>2</sub>-tanks are permitted; minimal size is 800 bar\*liters (4L x 200bar)
- each tank must be equipped with 100% O<sub>2</sub>-compatible regulator and submersible pressure gauge
- divers who do not own a diving computer that allows for gas switches underwater must apply the decompression stop times for air or the used Nitrox mixture.

#### Usage of Trimix

- because of the complex logistics and additional legal constraints in some countries, Trimix is not to be used within the framework of any Cave Diver 1 - 3 training (specialty course).

#### Usage of rebreathers and similar equipment

- is not to be used within the framework of Cave Diver 1 - 3 training (specialty course)



## Standards & Training System

### Usage of DPVs (Diving Propulsion Vehicles)

- is not to be used within the framework of Cave Diver 1 - 3 training (specialty course)

### Blending of gas mixtures

- As a general rule, all participants fill their tanks themselves, regardless of their content. Thus each diver is fully responsible himself for it and for the correct use of the mixture. This responsibility cannot be delegated to anyone else.
- After each blending and filling, the blender has to analyze the content. This measurement has to be repeated *before* the briefing at the diving-site!
- The organizers reserve the right to control the indicated contents at any time.

### Marking of O<sub>2</sub>-, Nitrox- / Trimix- tanks

- O<sub>2</sub> tanks have to be properly stamped. Painting of outside tank walls has to be according to colour code as set forth by national laws or international agreements. O<sub>2</sub> tanks must also carry a distinctive writing ("O<sub>2</sub>" / "Oxygen" / "Sauerstoff")
- all Nitrox/Trimix-tanks have to be properly and clearly marked with the usual EANx / NITROX or TRIMIX stickers/tags.
- all tanks that may be deposited somewhere in the cave during the dive have to be clearly marked with the name of the owner
- the actual content has to be indicated on a good readable content sticker/tag:
  - \* once more type of gas (EANx, Tmx)
  - \* fraction %O<sub>2</sub> / % N<sub>2</sub> / %He. This analysis has to be done by the blender after the blending process is finished and once more at the dive site by the user
  - \* MOD (maximum operation depth) in m/ft with indicating the used units
  - \* Minimum Operation Depth in m/ft for Tmx with an O<sub>2</sub> content of <20.8%
  - \* filling date / date of analysis
  - \* signature of the blender / of the person who made the tank content analysis
- in addition to this easily removable tag it is recommended to write the MOD in big size numbers (approx. 10cm / 4 in.) directly on the tank

### O<sub>2</sub>-Compatibility of tanks, valves and regulators

- Up to a content of 40%O<sub>2</sub>, no special manifolds or valves are requested
- Inner walls of the tanks, manifolds and valves and the regulators have to be 100% O<sub>2</sub>-compatible according to the corresponding regulations and laws. This is the task of the user (cleaning, use of correct grease). Each user carries the full responsibility alone.  
This holds true even more if pure O<sub>2</sub> is decanted during the blending process !
- All maintenance and trouble shooting of regulators and all other personal equipment is in the sole responsibility of each participant.



## Standards & Training System

### Appendix 4: Compulsory equipment for CMAS cave diving courses

Beyond the so-called standard diving equipment such as fins, masks, diving suit, there is the following list of specialized equipment that is compulsory for all international CMAS cave diving courses:

- 2 mono tanks, capacity 10-12L; DIN-outlets only; H- or Y-valve [zone1 only !]
  - 2 double tank rigs 2 x 10L; DIN-outlets; no connection (manifold) or one with isolator valve [zones 2+3]  
**Attention:** - for penetrations beyond 500m (1500ft) a 3rd tank is compulsory (min. volume 1400NL)  
- all tanks have to carry a valid stamp from nationally recognized hydro testing institute  
- every tank has to be equipped with a pressure gauge
  - 1-2 stage tanks (min. volume 7L) each with a complete regulator rig (incl. pressure gauge) [cd3 only]
  - 1 jacket or wings with a buoyancy of at least 20 L
  - 2 complete regulator rigs, each with 1st/2nd stage, pressure gauge, inflator  
(caution: inflator hoses for BC and drysuit must NOT be connected to the same 1st stage; at least 1 pressure gauge must have a self illumination analogue display)
  - 1 long hose, length approx. 1.8-2.1m (6-7ft) [from zone 2 on]
  - 1 spare mask [from zone 2 on]
  - 1 compass with self illuminating analogue display
  - 1 dive computer with stage decompression stop mode
  - 1 safety reel with approx. 20m line, dia. = 1.5 - 2mm [all courses; all zones]
  - 1 gap/jump-reel with approx. 50m line, dia. = 1.5 - 2mm [from zone 2 on]
  - 1 helmet (pref. with lamps attached) [from zone 2 on]
  - 1 main lamp, output approx. 700 Lumen (30-50W Halogen), min. burning time 2 hrs (to be carried that hands & fingers stay free for manual work)
  - 2 emergency lamps, output approx. 90 Lumen (4W Xenon), min. burning time 2
  - 2 solid stainless cutting tools (knives, cutters, cutting pliers, scissors), secured against dropping
  - 3 directional markers / line arrows
  - 3 non-directional markers ("cave cookies" / "line cookies")
  - 3-4 D-rings on the jacket/wings and/or carabines (spring safety hooks) on the belt to attach lamps reels etc.
- for Nitrox divers:** certificate + connection hose with high precision pressure gauge + O<sub>2</sub>-analyzer !

### Recommended additional equipment for intensive courses in remote areas:

- 1 pair of fins
- 1 pair of gloves (specially for dry suits)
- 1 complete regulator rig (incl. hose)
- 1 mechanical depth gauge with self illuminating analogue display / watch / dive table
- 2-3 pc. spare lead weights
- 1 high pressure hose with pressure gauge for connection tanks for filling and decanting
- 1 high pressure hose for pressure gauge
- straps for fins and masks
- 1 spare parts set for regulators
- batteries and accumulators for uw-lamps
- bulbs and fuses for lamps and chargers
- plug boards and connectors for foreign sockets**
- suitable tools for all parts of the equipment
- insulating tape of different colours
- silicone grease / O<sub>2</sub>-compatible lubrication material
- Aquasure or similar neoprene glue
- 1st aid box
- trekking-material (solid boots, rain coat, lines & ropes)
- sun blocker (cap etc.); insect repellent

Further additional materials according to personal needs and preferences.



## Standards & Training System

### Appendix 5: Guidelines for assessments

Standards allow the responsible course director - regardless of the type and level of certificate presented - not only to ask for an evaluation of the potential student's knowledge and skills but also of his/her physical performance (a so-called entry-assessment) if he feels the necessity to do so.

#### Requirements for an assessment:

- if student presents certificate from unknown organisation or from one that is not recognized by CMAS or has an otherwise doubtful reputation in the cave diving community.
- if the candidate has not been diving for a longer period, has received his training in a totally different environment (warm, clear waters, no currents, very shallow depths etc.)
- if there are doubts about the quality of the student's training, on the certifying organisation or on the responsible instructor
- whenever the course director has reasonable doubts on the student's *physical* performance
- whenever the candidate wishes it

#### Areas to be checked:

- physical performance (only on CD2 and CD3 level)
- practical skill (→ standard-drills)
- theoretical knowledge (→ MC-test)
- following / respecting safety rules

#### Equipment to be used:

- corresponding to level of certification and the zone
- especially for swimming drills: equipment corresponding to intended zone
- 100% conform with CMAS standards

#### Evaluation / Grading:

Evaluation and grading has to correspond to the level of the certificate presented by the candidate.

#### Duration:

0.5 - max. 1 day (practical work and theory-test)

#### Dive sites for practical assessment:

- level cave diver 1: mainly open water or cave entry
- level cave diver 2: overhead environment preferred; open water acceptable if results are not influenced by this environment
- level cave diver 3+: cave environment only (zones 2 and 3)

#### Fitness for diving:

A valid (< 1 year) medical attest for fitness for diving must be presented before the first entry into the water.

#### Distance fin swimming (endurance) test:

This evaluated exercise at the surface has to be carried out in full gear and by using a snorkel. It should be done in a lake or in a sheltered area in the sea (e.g. a bay). For safety reasons, individual buoyancy has to be adjusted so that the swimmer can stay without undue effort at the surface even with the jacket/wings completely deflated. The exercise has to be done only with a calm surface.

- **CD2 + CD3 (equipment corresponds to zone 2): 600m in max. 23 minutes**

If the candidate does not pass this test before the first training dive of the course, then he has to be refused and his further participation to be cancelled.

# CMAS Cave Diving



## Standards & Training System

### Standard-Drills and exercises:

drill / type of exercise	dive site	CD1	CD2
Donning complete equipment on land without help within reasonable time; equipm. conform with CMAS standards	on land	X	X
buddy-check (head-to-toe) + check for leakages on 3-5m	open water or cave entry	X	X
complete equipment donning at surface while swimming within reasonable time; equipment conform with CMAS standards	open water or cave entry	X	X
taking off/on and clearing mask at depth 10-15m	cave zone 1 or open water	X	---
switch to back-up mask at depth 10-15m	cave zone 1 or similar overhead environment	---	X
buddy rescue from depth of 20m with transport 50m at the surface	open water	---	X
following a fixed line without light over 80-100m	cave zone 2 or open water with mask glass blackened	---	X
use of long hose over distance of approx. 50m	cave zone 2	---	X
laying and fixing a line on a distance of approx. 50m	cave zonen 1 and 2 or open water	---	X
Shut-down Drill on a depth of 5 - 10m	cave zone 1 or open water	X	X



## Standards & Training System

### Appendix 6a: Standard drills & exercises for practical evaluation at CMAS Cave Diver 1 level

#### Remarks

To assure that cave diving training and evaluation within the CMAS system is done in accordance with the standards and that the *required* level of competence of the students is as close together as possible, CMAS has developed a number of standard drills and exercises for each level.

Every one of these exercises must be performed by the student at least once with a C grading (passed) or better during the course. Every exercise with a grading lower than C (not passed) must be repeated, until the student has attained *two consecutive* C gradings (or better).

Exercises with a binary Pass/Fail grading are safety related issues of great importance. Therefore, they are evaluated on every single training dive. Only two *Failed* gradings of these issues during the course are accepted.

#### Standard-Evaluation Scheme

All exercises are to be assessed following a uniform evaluation scheme, be it a grading with codes ranging from A - E or a digital Pass/Fail decision.

The standardized grading to be used is the following:

<b>A</b>	<b>very good; excellent</b>
<b>B</b>	<b>good</b>
<b>C</b>	<b>average, just passed</b>
<b>D</b>	<b>not passed (time, needed support etc.)</b>
<b>E</b>	<b>unable to finish drill; had to abort, emergency</b>

**Remark:** parts of the shut-down drill are: a) closing tank valve on the side of the leakage b) closing isolator valve, if any; c) switch to other regulator, d) pressure gauge control.

The following listed *standard exercises/drills* must be successfully performed at least once each:

Nr.	type of exercise	grading
1	complete partner-check (head-to-toe, no leakages)	A - E
2	shut-down drill in the entrance pool or open water in max. 45 sec.	A - E
3	correct laying a line (dist.=15-20m), starting at entrance	A - E
4	diving without light/visibility along a line (open water) with touch-contact, dist.=40-50m (blacked out mask glasses) as a PARTNER-EXERCISE	A - E
5	out-of-air situation; octopus-breathing towards the exit with touch-contact, dist.=40-50m ea. (as a donor/receiver) in overhead environment (zone 1) as a PARTNER-EXERCISE	A - E
6	UW-signs and signals (all 4 command signals and the most used 10 information- and actions signals)	A - E
7	uw distance swimming, dist.=250-300m, depth=10-20m, time = 15-20min; used to determine individual air consumption	no grading

In addition, the following personality- and safety aspects must be evaluated during all dives:

Nr.	type of exercise	grading
8	ability to act as a fully integrated team member on land and underwater	A - E
9	observation/respect of CMAS standards and safety rules	A - E
10	correctly gearing up; correct use of material; conform to CMAS standards	A - E



## Standards & Training System

### Appendix 6b: Standard drills & exercises for practical evaluation at CMAS Cave Diver 2 level

#### Remarks

To assure that cave diving training and evaluation within the CMAS system is done in accordance with the standards and that the *required* level of competence of the students is as close together as possible, CMAS has developed a number of standard drills and exercises for each level.

Every one of these exercises must be performed by the student at least once with a C grading (passed) or better during the course. Every exercise with a grading lower than C (not passed) must be repeated, until the student has attained *two consecutive* C gradings (or better).

Exercises with a binary Pass/Fail grading are safety related issues of great importance. Therefore, they are evaluated on every single training dive. Only two *Failed* gradings of these issues during the course are accepted.

#### Standard-Evaluation Scheme

All exercises are to be assessed following a uniform evaluation scheme, be it a grading with codes ranging from A - E or a digital Pass/Fail decision.

The standardized grading to be used is the following:

<b>A</b>	<b>very good; excellent</b>
<b>B</b>	<b>good</b>
<b>C</b>	<b>average, just passed</b>
<b>D</b>	<b>not passed (time, needed support etc.)</b>
<b>E</b>	<b>unable to finish drill; had to abort, emergency</b>

**Remark:** parts of the shut-down drill are: a) closing tank valve on the side of the leakage b) closing isolator valve, if any; c) switch to other regulator, d) pressure gauge control.

The following listed *standard exercises/drills* must be successfully performed at least once each:

Nr.	type of exercise	grading
1	complete partner-check (head-to-toe, no leakages)	A - E
2	correctly and completely donning equipment while swimming at the surface in max. 8minutes as a PARTNER-EXERCISE helping each other	A - E
3	shut-down drill in zone 1 (overhead) in max. 40 sec.	A - E
4	correct laying a line (dist.=25-30m), starting at entrance	A - E
5	diving without light/visibility along a line (open water) with touch-contact, dist.=100-150m (blacked out mask glasses) as a PARTNER-EXERCISE (zone 2)	A - E
6	out-of-air situation; octopus-breathing towards the exit with touch-contact, dist.=150m ea. (as a donor/receiver) in overhead environment (zone 2) as a PARTNER-EXERCISE	A - E
7	UW-signs and signals (all 4 command signals and the most used 10 information- and actions signals)	A - E
8	buddy rescue, minimum up to safety stop at 6m; depth + horizontal distance = approx. 50m, permanently securing continuous air supply; as a TEAM-EXERCISE (start in zone 2)	A - E
9	switch to back-up mask (zone 2)	A - E
10	find a "lost" main line with the safety reel (zone 2)	A - E
11	to cross and to close a jump with the jump-reel or spool (zone 2)	A - E
12	temporarily closing a gap by using a gap reel (zone 2)	A - E
13	continuously connecting all reels of a group and laying a temporary, continuous main line, starting at entrance (TEAM-EXERCISE)	A - E
14	uw distance swimming, dist.=250-300m, depth=10-20m, time = 15-20min; used to determine individual air consumption; comparison to CD1	no grading



# CMAS Cave Diving

---



## Standards & Training System

In addition, the following personality- and safety aspects must be evaluated during all dives:

<b>Nr.</b>	<b>type of exercise</b>	<b>grading</b>
15	ability to act as a fully integrated team member on land and underwater	A - E
16	observation/respect of CMAS standards and safety rules	A - E
17	correctly gearing up; correct use of material; conform to CMAS standards	A - E



## Standards & Training System

### Appendix 6c: Standard drills & exercises for practical evaluation at CMAS Cave Diver 3 level

#### Remarks

To assure that cave diving training and evaluation within the CMAS system is done in accordance with the standards and that the *required* level of competence of the students is as close together as possible, CMAS has developed a number of standard drills and exercises for each level.

Every one of these exercises must be performed by the student at least once with a C grading (passed) or better during the course. Every exercise with a grading lower than C (not passed) must be repeated, until the student has attained *two consecutive* C gradings (or better).

Exercises with a binary Pass/Fail grading are safety related issues of great importance. Therefore, they are evaluated on every single training dive. Only two *Failed* gradings of these issues during the course are accepted.

#### Standard-Evaluation Scheme

All exercises are to be assessed following a uniform evaluation scheme, be it a grading with codes ranging from A - E or a digital Pass/Fail decision.

The standardized grading to be used is the following:

<b>A</b>	<b>very good; excellent</b>
<b>B</b>	<b>good</b>
<b>C</b>	<b>average, just passed</b>
<b>D</b>	<b>not passed (time, needed support etc.)</b>
<b>E</b>	<b>unable to finish drill; had to abort, emergency</b>

**Remark:** parts of the shut-down drill are: a) closing tank valve on the side of the leakage b) closing isolator valve, if any; c) switch to other regulator, d) pressure gauge control.

The following listed *standard exercises/drills* must be successfully performed at least once each:

Nr.	type of exercise	grading
1	complete partner-check (head-to-toe, no leakages)	Pass/Fail
2	correctly and completely donning equipment while swimming at the surface in max. 6minutes as a PARTNER-EXERCISE helping each other	Pass/Fail
3	Shut-down drill in zone 2 in max. 40 sec.	A - E
4	correct laying a line (dist.=50m), starting at entrance (TEAM-EXERCISE)	A - E
5	diving without light/visibility along a line (open water) with touch-contact, dist.=APPROX. 200m (blacked out mask glasses) as a PARTNER-EXERCISE (zone 2)	A - E
6	out-of-air situation; octopus-breathing towards the exit with touch-contact, dist.=150m ea. (as a donor/receiver) in overhead environment (zone 2) as a PARTNER-EXERCISE	A - E
7	UW-signs and signals (all 4 command signals and the most used 10 information- and actions signals)	Pass/Fail
8	buddy rescue, minimum up to safety stop at 6m; depth + horizontal distance = approx. 80m, permanently securing continuous air supply; as a TEAM-EXERCISE (start in zone 2)	A - E
9	switch to back-up mask (zone 2)	Pass/Fail
10	find a "lost" main line with the safety reel (zone 2)	A - E
11	to cross and to close a jump with the jump-reel or spool (zone 2)	A - E
12	temporarily closing a gap by using a gap reel (zone 2)	A - E
13	repairing a cut guideline (TEAM-WORK)	A - E
14	stage tank handling: deposits, selection of location, recollection (zone 2)	A - E
15	not announced emergency (zone 2); COMPLETE TEAM-EXERCISE	A - E
16	freeing himself after entanglement in permanent line with tank manifold (zone 2).	A - E
17	guiding a group (leadership) (observing rule of thirds / teaming up / task assignments / buddy-checks, briefings/debriefings by student, )	A - E

# CMAS Cave Diving

---



## Standards & Training System

In addition, the following personality- and safety aspects must be evaluated during all dives:

<b>Nr.</b>	<b>type of exercise</b>	<b>grading</b>
18	ability to act as a fully integrated team member on land and underwater	A - E
19	observation/respect of CMAS standards and safety rules	A - E
20	correctly gearing up; correct use of material; conform to CMAS standards	A - E



### Appendix 7: Theory tests (topics, structure, allocated questions)

#### A7.1 Cave Diver 1 - 3

##### A7.1.1 types / overall content

CMAS certificate designation	Cave Diver 1	Cave Diver 2	Cave Diver 3
generally used designation	<b>Cavern Diver</b>	<b>Cave Diver</b>	<b>Full Cave Diver</b>
type of test	MC only	MC only	MC+free text
MC: number of questions	20	30	30
open text: number of questions	----	----	10
passing ratio	80%	80%	80%
<b>total number of questions</b>	<b>20</b>	<b>30</b>	<b>40</b>
<i>MC: multiple choice (4 answers per question; 1 or more can be correct)</i>			
<i>Passing ratio: minimum number of correct answers</i>			

##### A7.1.2 topics / allocated questions

	CMAS certificate designation	Cave Diver 1	Cave Diver 2	Cave Diver 3
	generally used designation	Cavern Diver	Cave Diver	Full Cave Diver
	<b>Topic</b>			
1	Physics	2	2	2
2	Physiology	2	2	2
3	Gases / Dekompression	0	2	3
4	Cave Genesis / -Protection	2	2	3
5	Ethics (Diver's Etiquette)	1	1	2
6	Zones	1	2	2
7	CD Equipment	4	4	4
8	CD Techniques (Orient./Knots/Comm.)	4	4	4
9	Dive Organisation	0	2	3
10	Dive Planning	0	2	3
11	Emergencies / Emerg. Management	2	2	3
12	Legal Aspects	0	2	2
13	Course Structures / -Organisation	0	0	2
14	Teaching Methodology	0	0	1
15	Standards/Safety Rules	2	3	4
	<b>Total:</b>	<b>20</b>	<b>30</b>	<b>40</b>



### A7.2 Cave Diving Instructor 1 - 3

#### A7.2.1 types / overall content

CMAS certificate designation	Cave Diving Instructor 1	Cave Diving Instructor 2	Cave Diving Instructor 3
generally used designation	<b>Cavern Diving Instructor</b>	<b>Full Cave Diving Instructor</b>	<b>Cave Diving Staff Instructor</b>
type of test	MC only	MC+free text	no written exam / master thesis req.
MC: number of questions	50	40	
open text: number of questions	----	10	
passing ratio	80%	80%	
<b>total number of questions</b>	<b>50</b>	<b>50</b>	
<i>MC: multiple choice (4 answers per question; 1 or more can be correct)</i>			
<i>Passing ratio: minimum number of correct answers</i>			

#### A7.2.2 topics / allocated questions

	CMAS certificate designation	Cave Diving Instructor 1	Cave Diving Instructor 2	Cave Diving Instructor 3
	generally used designation	<b>Cavern Diving Instructor</b>	<b>Full Cave Diving Instructor</b>	<b>Cave Diving Staff Instructor</b>
	<b>Topic</b>			
1	Physics	2	1	no theory exam, but Master Thesis required
2	Physiology	2	1	
3	Gases / Dekompression	2	3	
4	Cave Genesis / -Protection	3	2	
5	Ethics (Diver's Etiquette)	2	2	
6	Zones	1	0	
7	CD Equipment	6	8	
8	CD Techniques (Orient./Knots/Comm.)	5	5	
9	Dive Organisation	2	1	
10	Dive Planning	2	1	
11	Emergencies / Emerg. Management	4	4	
12	Legal Aspects	4	4	
13	Course Structures / -Organisation	6	8	
14	Teaching Methodology	4	5	
15	Standards/Safety Rules	5	5	
	<b>Total:</b>	<b>50</b>	<b>50</b>	



### Appendix 8: The CMAS cave diver's etiquette

- 1) We want to be (and to stay) welcomed guests everywhere and thus show a corresponding attitude.
- 2) We use the least possible number of vehicles for transportation to our dive sites and at the site we do not block any roads, footpaths and entries or exits.
- 3) We are polite with local residents and other guests on site and respect their justified concerns and requests as well as we respect local legislation.
- 4) At the site we change our dresses discretely and always strive for showing a correct attitude and behaviour in public.
- 5) We do not produce any unnecessary emissions, we don our equipment while keeping a low profile and in orderly manner, we do not leave any trash behind and we restrict our presence to the necessary minimum.
- 6) Our attitude towards other divers - regardless which organisation they are coming from - is the one of good colleagues; there is no room for arrogance of any kind.
- 7) Safety in cave diving is our honest and most focused concern; we strictly abide to the standards, safety rules and procedures and are defensively diving
- 8) I've got a top training, because I know: **every incident may create a dive ban more** and **without proper certification, there is no insurance coverage.**
- 9) Alcohol and drugs before diving activities are both deadly sins and are completely banned in our sport.
- 10) The underwater attitude is so that any impairment of the flora and fauna of the cave and its environment is reduced to a bare minimum and the former state of the delicate ecosystem will be retained.

***Please keep in mind: ONE single disorderly behaviour can destroy the good reputation of a group which has been carefully built up over the years and may cause the closing of a site !***



### Appendix 9: Current line sizes and US designation codes

#### Diameter and designation codes for lines

In Europe and in all other countries with the metric system in use, line size (diameter) is expressed in mm (1 Millimeter = 0.001 Meter). However, especially in the USA and some other countries, a numbering code is used, expressing the diameter of the line as a fraction of an inch (1 in. = 25.4mm).

Following is a table with the most currently used sizes (the # - sign is spelled as "number", the sign " " means "inch").

In countries with the metric system the following line sizes are used: 1.5mm / 2mm / 2.5mm / 3mm.

Please note that regardless of the size only *braided* lines should be used and not the cheaper *laid* or *twisted* lines. The values indicated below for tensile strength and breaking point are average values for Nylon.

Code	Diameter in metric units [mm]	Diameter in US-units [in]	approx. tensile strength/breaking point (Nylon) [kg]	approx. tensile strength/breaking point (Nylon) [lbs]
#18	1.58	1/16" = 0.0625	65.4	144
#24	1.86	0.073	104	230-250
#36	2.11	0.083	150	330-360
#48	2.48	0.098	182	405-550
1/8"	3.18	0.125	331	728

The size mostly used is #24 or #36, very close to the sizes used in Europe. For caves with strong currents and walls with sharp cutting edges, even a #48 or 1/8" line may be preferable.



### Appendix 10: Knots, Bends and Hitches

A knot is a method for fastening or securing linear material such as rope by tying or interweaving. It may consist of a length of one or more segments of rope, string, webbing, twine, strap or even chain interwoven so as to create in the line the ability to bind to itself or to some other object - the "load". It can be used to fix a piece of equipment (or any other suitable item) to a line or rope. A knot can be generated by taking the loose end of a line (the working end), by pushing it through a loop and by tightening then, or by connecting different lines and ropes. The manual skill to make a correct knot and the knowledge about which knot to use for what purpose is absolutely essential for carrying out of several activities directly linked to cave-diving, especially for safety-related issues.



#### A10.1 Potential fields of usage

Knots are used for:

- *securing and connecting persons*
- *connecting lines and ropes*
- *shortening of lines and ropes and putting them under tension*
- *securing other knots and bends*
- *securing and lifting of loads*
- *securing equipment and parts thereof*
- *anchoring on moorings*
- *adding some weight on line ends*



#### A10.2 Overview of most important knots, bends and hitches for divers

- Overhand Knot
- Figure Eight Knot (single / double)
- Reef Knot
- Bowline (single / double)
- Sheet Bend (single/double, on slip)
- Anchor Bend
- Clove Hitch
- Fisherman's Knot
- Half Hitch / 2 Half Hitches
- Round Turn with 2 Half Hitches
- Garda-Knot



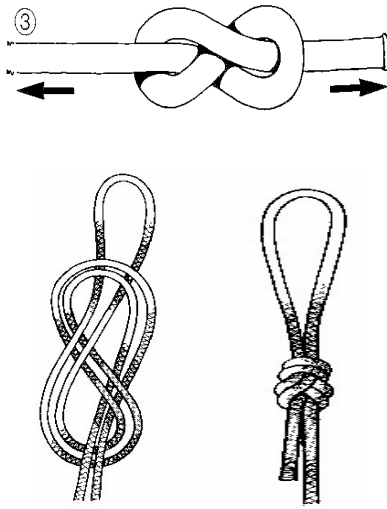
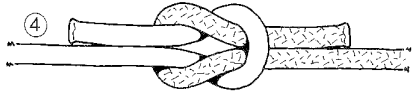

### A10.3 Knots for CD2 and CD3 training

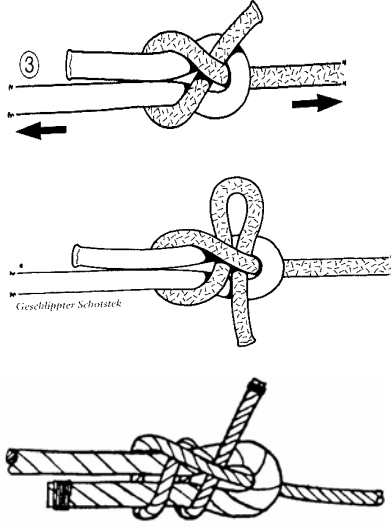
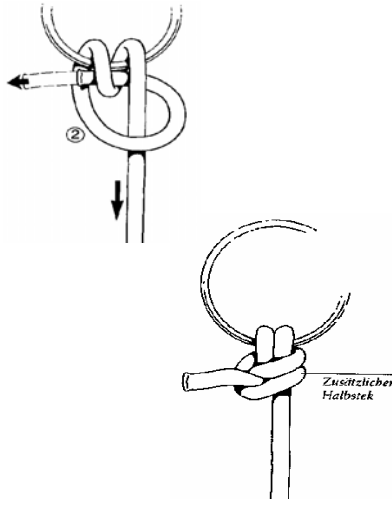
English term		
<p><b>Overhand Knot</b></p> 	<p><b>Figure Eight Knot (single / double)</b></p> 	<p><b>Reef Knot</b></p> 
<p><b>Bowline (single / double)</b></p> 	<p><b>Sheet Bend (single / double)</b></p> 	<p><b>Anchor Bend</b></p> 



English term		
<p><b>Fisherman's Knot</b></p>	<p><b>Clove Hitch</b></p>	<p><b>Half Hitch / 2 Half Hitches</b></p>

<p><b>Round turn + 2 Half Hitches</b></p>	<p><b>Garda Knot</b></p>
---	--------------------------